



# ELAN

**HS-5100, HS-5200, HS-5400, HS-5800**

**ANALOGUE ADDRESSABLE CONTROL PANELS**

Installation, Programming & Commissioning  
Manual

The operation and functions described in this manual are available from  
Software Version 5600-060-01 onwards.

Approved Document UI-ELAN-01 Revision 07

# Specifications:



Item	Specification Details			
Part Number:	HS-5100	HS-5200	HS-5400	HS-5800
Enclosure	Steel IP30 RAL7035	Steel IP30 RAL7035	Steel IP30 RAL7035	Steel IP30 RAL7035
Dimensions H x W x D mm	345 x 345 x 85 (/M) 345 x 430 x 120 (/L) 475 x 450 x 120 (/D) 475 x 450 x 190	345 x 430 x 120 (/L) 475 x 450 x 120 (/D) 475 x 450 x 190	475 x 450 x 120 (/D) 475 x 450 x 190 (/E) 750 x 450 x 190	750 x 450 x 190
Rack Module	(/R) 266 x 482 x 125	(/R) 266 x 482 x 125	(/R) 266 x 482 x 125	
Weight (excluding batteries)	6Kg (/M) 8Kg, (/L) 10Kg, (/D) 12kg	8Kg (/L) 10Kg, (/D) 12Kg	10Kg (/D) 12Kg, (/E) 18kg	20Kg
19" Rack Enclosures IP55				
MXM-510-16U (22Kg)	730 x 535 x 230	730 x 535 x 230	730 x 535 x 230	
MXM-510-20U (25Kg)	910 x 535 x 230	910 x 535 x 230	910 x 535 x 230	
Temperature	-5°C to 40°C	-5°C to 40°C	-5°C to 40°C	-5°C to 40°C
Humidity (RH)	95 % Max	95 % Max	95 % Max	95 % Max
Operating Altitude	This equipment is not certified to operate at altitudes greater than 2000 metres above sea level.			
Cable Entries (20mm knockouts)	13x top / 8x top rear (/M) 17x top / 11x top rear / 2 bottom (/L) 19x top / 11x top rear / 2 bottom (/D) 30x top / 11x top rear / 3 bottom	17x top / 11x top rear / 2 bottom (/L) 19x top / 11x top rear / 2 bottom (/D) 30x top / 11x top rear / 3 bottom	19x top / 11x top rear / 2 bottom (/D) 30x top / 11x top rear / 3 bottom (/E) 30x top / 6x top rear / 3 bottom plus 2x double knockout rear	30x top / 6x top rear / 3 bottom plus 2x double knockout rear
AC Supply (ratings marked on label inside panel – see section 2.1 for location)	200-240V AC 50 -60Hz Hz AC 1.0A max	200-240V AC 50 -60Hz Hz AC 1.4A max	200-240V AC 50 -60Hz Hz AC 1.4A max	200-240V AC 50 -60Hz Hz AC 2.8A max
Safety	EN62368-1, Class I, Pollution degree 2, Overvoltage Category II			
Battery Capacity	24V 4Ah Internal (min) 24V 7Ah Internal (max) (/M) 24V 12Ah Internal (max) (/L) 24V 18Ah Internal (max) (/D) 24V 24Ah Internal (max)	24V 4Ah Internal (min) 24V 12Ah Internal (max) (/L) 24V 18Ah Internal (max) (/D) 24V 45Ah Internal (max)	24V 4Ah Internal (min) 24V 18Ah Internal (max) (/D) 24V 45Ah Internal (max) (/E) 24V 45Ah Internal (max)	2x 24V 4Ah Internal (min) 2x 24V 18Ah Internal (max) OR 1x 24V 45Ah Internal (max) / 1x 24V 45Ah External (max)
Charging Current	1.0A Temp Compensated	2.0A Temp Compensated	2.0A Temp Compensated	2x 2.0A Temp Compensated
Deep discharge cut-off	20.0V			
Power Supply	24V DC, 3A High Efficiency Off-Line Switched Mode PSU	24V DC, 4A High Efficiency Off-Line Switched Mode	24V DC, 5A High Efficiency Off-Line Switched Mode PSU	2x 24V DC, 5A High Efficiency Off-Line Switched Mode
Output Voltage <sup>1</sup>	18.0V – 28.0V			
Ripple (Vpkpk)	200mV			
Max Battery Ohms	1Ω ± 0.1Ω			
Imin	125mA			
Imax(a)	1.6A			
Imax(b) <sup>2</sup>	3.0A			
Number of Fire Zones	200 max (2000 when networked)	200 max, across 2 loops (2000 when networked)	200 max, across 4 loops (2000 when Networked)	400 max, across 8 loops (2x 4 loops) (2000 when Networked)
Number of Loops	1	1-2	1 to 4	2 to 8 (2x 1 to 4)
Loop Current <sup>3</sup>	500mA max.	500mA max. per Loop	500mA max. per Loop	500mA max. per Loop
Devices per Loop	Apollo 126 devices per loop (max) – MXP-502 (or MXP-568) Hochiki 127 devices per loop (max) – MXP-502 (or MXP-568) Nittan 254 devices per loop (max) – requires MXP-567			
Protocols	Apollo, Apollo Core, Hochiki, Nittan.			
Sounder Outputs <sup>3</sup>	2 x 1A Programmable	2 x 1A Programmable	4 x 1A Programmable	8 (2x4) x 1A Programmable
Relay Outputs (Programmable)	2 x 1A 30VAC/DC (max) 10mA 5V (min)	2 x 1A 30V AC/DC (max) 10mA. 5V (min)	2 x 1A 30V AC/DC (max) 10mA. 5V (min)	4 (2x2) x 1A 30V AC/DC (max) 10mA. 5V (min)
Auxiliary Output <sup>3 4</sup>	24V DC, 500mA			
Display	LCD White backlit 240 x 64 Graphical LCD			
Programmable Inputs	8x Switch inputs, 1 x Hard wired input and Four x programmable push buttons c/w slide in labels			
USB/RS232	USB B type interface and RS232 for PC connection			
Ad-Net Network	Optional	Optional	Optional	ST4/STD – MXP-503 ST7/FT – MXP-509
Event Log	5000 Event & Diagnostic + 500 Fire			

As our policy is one of constant product improvement the right is therefore reserved to modify product specifications without prior notice. E&OE

<sup>1</sup> Minimum/maximum specifications for the AUX, and Sounder outputs. Detector Loop voltage is not dependant on AC or battery voltage.

<sup>2</sup> Only applicable if the panel is configured to turn off the charger in alarm. Otherwise, Imax(b)=Imax(a).

<sup>3</sup> Total output current from panel not to exceed Imax(b) less internal power consumption.

<sup>4</sup> Aux supply tracks a maximum of 0.5V below battery terminal voltage when no mains supply is available.



<b>Table of Contents</b>		<b>Page</b>
<b>1</b>	<b>INTRODUCTION .....</b>	<b>5</b>
1.1	STANDARDS.....	5
1.2	CAUTIONS AND WARNINGS .....	6
1.3	DESCRIPTION .....	6
1.3.1	5000 Series.....	6
1.3.2	5000V Series .....	6
1.4	EN54 FUNCTIONS .....	7
1.5	EN54 OPTIONAL FEATURES WITH REQUIREMENTS .....	8
1.6	INSTALLATION APPROVALS .....	9
1.6.1	Fire System Installations.....	9
1.6.2	Wiring Regulations.....	9
<b>2</b>	<b>INSTALLATION.....</b>	<b>10</b>
2.1	IDENTIFICATION OF PARTS .....	10
2.1.1	HS-5100.....	10
2.1.2	HS-5200.....	11
2.1.3	HS-5400.....	12
2.1.4	HS-5800.....	12
2.2	INSTALLING THE ENCLOSURE .....	13
2.2.1	Opening the Enclosure Cover .....	13
2.2.2	Removing the Chassis .....	13
2.2.3	Mounting the Enclosure .....	13
2.2.4	Install the Chassis.....	14
2.2.5	Recommended Cable Routing Arrangement .....	15
2.3	LOOP DRIVER INSTALLATION.....	15
2.3.1	Fitting the cards .....	16
2.3.2	Removing a Loop Driver Card.....	16
2.4	PLUG-IN / PERIPHERAL BUS MODULES .....	16
2.4.1	Routing Interface Card (Plug-In) .....	17
2.4.2	2-Way Relay Card (Plug-In).....	18
2.4.3	Network Card.....	18
2.4.4	Peripheral Module Chassis Mounting.....	19
2.5	WIRING INSTALLATION.....	19
2.5.1	AC Mains Wiring .....	20
2.5.2	Battery Installation.....	20
2.5.3	Detector Loop Installation .....	24
2.5.4	Sounder Circuits .....	25
2.5.5	Network Interface.....	26
2.5.6	Relay Circuits.....	27
2.5.7	Auxiliary Supply Output.....	27
2.5.8	Isolated Peripheral Bus Interface .....	27
2.5.9	Switch Inputs.....	28
2.5.10	RS232 Interface.....	28
2.5.11	USB Interface (Type B).....	28
2.5.12	Routing Interface .....	29
<b>3</b>	<b>PROGRAMMING.....</b>	<b>30</b>
3.1	INTRODUCTION .....	30
3.1.1	Access Levels .....	30
3.1.2	Memory Lock .....	30
3.1.3	Navigating through menus .....	30
3.1.4	Changing Text Descriptions .....	31
3.1.5	Numeric data entry.....	32
3.2	LEVEL 3 MENU FUNCTIONS .....	32
3.3	RECOMMENDED PROGRAMMING PROCEDURE .....	33
3.3.1	Loops.....	33
3.3.2	Loops – View/Edit .....	33
3.3.3	Loops – Auto Learn.....	38
3.3.4	Loop – Calibrate.....	39
3.3.5	Loop - History.....	39
3.3.6	Loop – Meter.....	40

3.3.7	Loop – Scope .....	40
3.3.8	Zones .....	40
3.3.9	Exit .....	40
3.3.10	Disable .....	41
3.3.11	Enable .....	41
3.3.12	View Options .....	41
3.3.13	Passwords.....	41
3.3.14	Time and Date.....	42
3.3.15	PC Config.....	42
3.3.16	EN54-13 .....	42
3.3.17	Setup.....	43
3.3.18	Display .....	45
3.3.19	Panel .....	46
3.3.20	Output Groups.....	46
3.3.21	Investigation Delays .....	49
3.3.22	Test .....	50
3.3.23	LED Indications .....	50
<b>4</b>	<b>SERVICE AND MAINTENANCE .....</b>	<b>51</b>
4.1	<b>MAINTENANCE SCHEDULE .....</b>	<b>51</b>
4.1.1	Daily Actions.....	51
4.1.2	Monthly Actions .....	51
4.1.3	Quarterly Actions .....	51
4.1.4	Annual Actions.....	51
4.2	<b>REPLACEMENT OF COMPONENTS.....</b>	<b>52</b>
4.2.1	Batteries .....	52
4.2.2	Liquid Crystal Display .....	53
<b>5</b>	<b>APPENDICES .....</b>	<b>54</b>
5.1	<b>APPENDIX 1 – FORGOTTEN LEVEL 3 PASSWORD.....</b>	<b>54</b>
5.2	<b>APPENDIX 2 – RECOMMENDED FIRE RATED CABLES.....</b>	<b>55</b>
5.2.1	Detector Loop Lengths – Apollo, Hochiki and AV .....	55
5.2.2	Sounder Circuit Lengths .....	56
5.2.3	Fire / Fault Routing Circuit Lengths .....	56
5.2.4	Network Cables .....	56
5.3	<b>APPENDIX 3 – BATTERY STANDBY CALCULATION CHART .....</b>	<b>57</b>
5.4	<b>APPENDIX 4 – CAUSE AND EFFECT PROGRAMMING EXAMPLE.....</b>	<b>58</b>
5.4.1	Introduction.....	58
5.4.2	Output Groups .....	58
5.4.3	Styles.....	58
5.4.4	Output Group Programming .....	58
5.5	<b>APPENDIX 5 – OTHER USEFUL DOCUMENTS .....</b>	<b>60</b>
5.6	<b>APPENDIX 6 –NETWORK DESIGN PRINCIPLES .....</b>	<b>61</b>
5.6.1	Mandatory Functions .....	61
5.6.2	Network Wiring .....	61
5.6.3	Parent Functions .....	61
5.7	<b>APPENDIX 7 – HS SERIES PRODUCT CAPABILITIES / MAX LIMITS.....</b>	<b>62</b>

# 1 Introduction

## 1.1 Standards

HAES Technologies declares that the products identified below conform to the essential requirements and other relevant provisions specified in the following CE and UKCA directives and regulations.

		22	<b>D.o.P. HS-5000</b> <b>D.o.P. HS-UKCA-5000</b>
EN54-2: 1997 +A1:2006 Control and indicating equipment for fire detection and fire alarm systems for buildings. Provided options: <ul style="list-style-type: none"> <li>• Outputs to Fire Alarm Devices</li> <li>• Output to Fire Routing Equipment</li> <li>• Output to Fire Protection Equipment</li> <li>• Output to Fault Routing Equipment</li> <li>• Investigation Delays to Outputs</li> <li>• Dependency on more than one alarm signal</li> <li>• Fault Signals from Points</li> <li>• Disablement of Points</li> <li>• Alarm Counter</li> <li>• Test Condition</li> <li>• Standardised Input / Output</li> </ul>			
EN54-4: 1997 +A1:2002 +A2:2006 Power supply equipment for fire detection and fire alarm systems for buildings			
<b>HS-5100, HS-5200, HS-5400, HS-5800</b>			



- Construction Products Regulation 305/2011 (EN54-2 EN54-4)
- Low Voltage Directive 2014/35
- Electromagnetic Compatibility Directive 2014/30
- RoHS Directive 2015/863.
- REACH Regulation 1907/2006
- WEEE Regulations 2012/19



- S.I. 2019/465 Construction Products Regulation (EN54-2 EN54-4)
- S.I. 1101/2016 Electrical Equipment (Safety) Regulations
- S.I. 1091/2016 Electromagnetic Compatibility (EMC) Regulations
- S.I. 2012/3032 RoHS Regulations 2012
- S.I. 2020/1577 UK Reach Regulations
- S.I. 2018/102 WEEE Regulations

## 1.2 Cautions and Warnings



**BEFORE INSTALLATION – Refer To the Ratings shown inside the product and to the ‘Specifications Chart’ in this document. Please read this manual carefully. If you are unclear on any point DO NOT proceed. Contact the manufacturer or supplier for clarification and guidance.**



**Only trained skilled service personnel should undertake the Installation, Programming and Maintenance of this equipment.**



**This product has been designed to comply with the requirements of the Low Voltage Safety and the EMC Directives. Failure to follow the installation instructions may compromise its adherence to these standards.**



**This equipment is constructed with static sensitive components. Observe anti-static precautions at all times when handling printed circuit boards. Wear an anti-static earth strap connected to panel enclosure earth point. Before installing or removing any printed circuit boards remove all sources of power (mains and battery).**



**Where you see the “PC Only” symbol, these features can either only be set-up using the PC Configuration Tool or there are additional options that are only available via the PC Configuration Tool.**

## 1.3 Description

This manual covers the installation, programming and commissioning of the *Elan Series* Fire Alarm Control Panels. This manual provides generic programming and installation information. Refer to the appropriate protocol application note for further and specific information for each protocol.

Refer to the User Manual (Document No. UI-ELAN-02) for details of how to operate the panel.

All panel models are available in a range of enclosure sizes and with a range of alternative optional features.

### 1.3.1 5000 Series

The 5100 is a Single Loop, Analogue Addressable Fire Alarm Control Panel.

The 5200 is a Multiple Loop, Analogue Addressable Fire Alarm Control Panel with provision for up to two loops.

The 5400 is a Multiple Loop, Analogue Addressable Fire Alarm Control Panel with provision for up to four loops.

The 5800 is a Multiple Loop, Analogue Addressable Fire Alarm Control Panel with provision for up to eight loops.

All above models are designed for use with the Apollo (Discovery, Explorer, XP95 and Series 90) and Hochiki (ESP) fire detection devices.

### 1.3.2 5000N Series

The HS-5100N is a Single Loop, Analogue Addressable Fire Alarm Control Panel.

The HS-5200N is a Two Loop, Analogue Addressable Fire Alarm Control Panel.

The HS-5400N is a Multiple Loop, Analogue Addressable Fire Alarm Control Panel with provision for up to four loops.

All above models are designed for use with Nittan fire detection devices





**Install the panel, detection loops, sounder circuits, etc. in accordance with the instructions in Section 2 and then program the operation in accordance with the instructions detailed in Section 3.**

## 1.4 EN54 Functions

	<p>This Fire Alarm Control Panel is compliant with the requirements of EN54-2 (1997) and EN54-4 (1997) and EN54-13 (2005). In addition to the basic requirements, the following optional functions are provided and these comply with the requirements of EN54.</p>
---	---

	C.I.E Optional Functions		EN54-2 Clause
	Indication Outputs Controls	<b>Outputs to Fire Alarm Devices</b> <b>Outputs to Fire Routing Equipment</b> <b>Output to Fire Protection Equipment</b> Investigation Delays to Outputs Co-incidence Detection  Alarm Counter Fault Signals from Points Output to Fault Routing Equipment Disablement of Points Test Condition Standardised I/O	7.8 7.9 7.10 7.11 7.12 Type B & Type C 7.13 8.3 8.9 9.5 10 11

	P.S.E Functions		EN54-4 Clause
	Operation from a main power supply Operation from a standby battery Monitor and Charge the Standby Battery Recognise and Notify Supply Faults		5.1 5.2 5.3 5.4

	System Functions		EN54-13 Clause
	Transmission Path Integrity Networks (non hierarchical)		4.5 4.3

	This Fire Alarm Control Panel also supports additional functions that are not covered by EN54. These are as follows:	
	Additional Function	Refer to Paragraphs
	Auxiliary Power Supply Output	<b>2.5.7</b>
	Auxiliary Relay Outputs	<b>2.5.6</b>
Programmable Cause / Effect on Outputs (Phased Evacuation)	<b>5.4</b>	
Printer Option	<b>User Manual</b>	

## 1.5 EN54 Optional Features with Requirements

In addition to the mandatory requirements of EN54 Part 2, the Control and Indicating Equipment (CIE) supports the following optional features with requirements: -

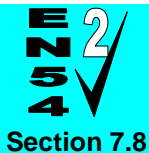

Section 7.8

### Outputs to Fire Alarm Devices.

The C.I.E has provision for connection to Fire Alarm Devices. It is possible to Silence and Resound the alarms at Level 2. Refer to the User Manual for further information.

Refer to Sections **3.3.20** and **3.3.21** for information on output programming.

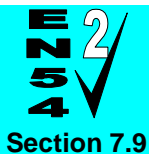

Section 7.9

### Outputs to Fire Routing Equipment.

The C.I.E has provision to signal the fire condition to a remote receiving station such as the fire brigade office. Requires installation of a routing interface card. Refer to Sections **2.4.1**, **2.5.12**, **3.3.20**, and **3.3.21** for further information.

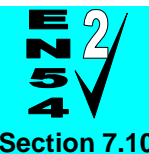

Section 7.10

### Outputs to Fire Protection Equipment.

The C.I.E has provision to signal the fire condition to a remote receiving station such as the fire brigade office. Requires installation of a routing interface card. Refer to Sections **2.4.1**, **2.5.12**, **3.3.20**, and **3.3.21** for further information.

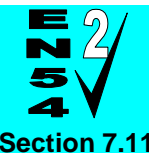

Section 7.11

### Delays to Outputs.

The C.I.E has provision for Output and Investigation Delays. Refer to Sections **3.3.20** & **3.3.21** for further information

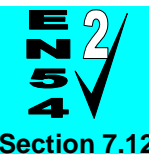

Section 7.12

### Coincidence Detection.

The C.I.E has provision for Coincidence Detection. Refer to Section **3.3.20** for further information. Types A, B and C are supported.

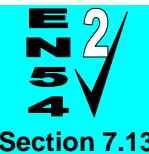

Section 7.13

### Alarm Counter.

The C.I.E has provision to record the number of times that the fire alarm condition is entered. Refer to the User Manual for further information.

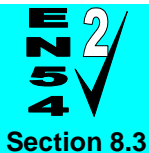

Section 8.3

### Fault Signals from Points.

The C.I.E is able to receive and process fault signals from points. These are indicated on a per zone basis. Refer to the User Manual for further information.

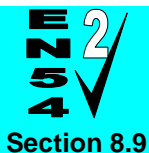

Section 8.9

### Outputs to Fault Routing Equipment.

The C.I.E has provision to signal the fault condition to a remote receiving station such as the service centre office. Requires installation of a routing interface card. Refer to Sections **2.4.1**, **2.5.12**, **3.3.20**, and **3.3.21** for further information.



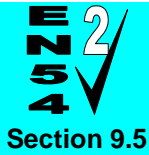

#### **Disabling of Points.**

The C.I.E has provision for enabling and disabling signals from points. Refer to the User Manual for further information.

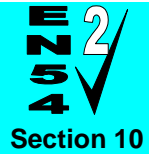

#### **Test Condition.**

The C.I.E has provision for testing the installation on a per zone basis. Refer to the User Manual for further information.



#### **Standardised Input / Output interface.**

Standardised I/O interfaces are supported over the *Ad-Net* Network.

## **1.6 Installation Approvals**

### **1.6.1 Fire System Installations**

The panel must be installed and configured for operation in accordance with these instructions and the applicable code of practice or national standard regulations for fire systems installation (for example BS5839-1) appropriate to the country and location of the installation.

### **1.6.2 Wiring Regulations**

The panel and system must be installed in accordance with these instructions and the applicable wiring codes and regulations (for example BS7671) appropriate to the country and location of the installation.

#### **Insulation coordination for equipment within low voltage systems:**

The normal category for fire detection and fire alarm products (and associated equipment) is as permanently connected equipment supplied from the building wiring (Overvoltage Category II). The equipment is not classified as being an integral part of the building wiring (Overvoltage Category III).

In accordance with EN62368-1, the products are assessed to, and comply with, the requirements for Overvoltage Category II devices for connection to the AC Mains supply.

This category is the normal category for this type of equipment and installation and the use of additional surge protection devices (SPD) is not normally required.

However:

- If the equipment is subjected to special requirements with regard to reliability and availability, or
- If the equipment is likely, when installed, to be subjected to transient over-voltages that exceed Category II, then

Additional surge protection devices (SPD) shall be provided in the AC Mains Supply feed to the equipment to limit any overvoltage transients to the levels of Category II.

## 2 Installation

### 2.1 Identification of Parts

The following diagrams show the major parts of the panels.

#### 2.1.1 HS-5100

##### /S Enclosure comprises:

Back Box

Base Card with 1x Loop Driver mounted onto a Chassis Plate

Door with Display Card mounted onto a fascia plate. Key-Lock.

Option for one key-switch.

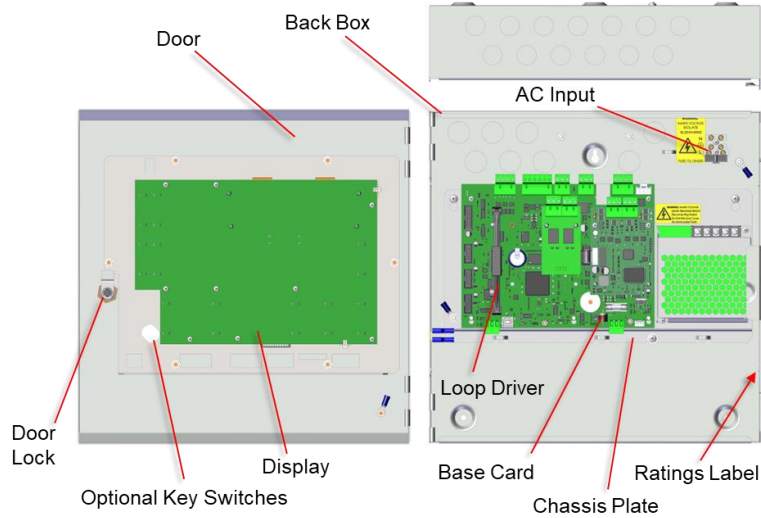

##### /M Enclosure comprises:

Back Box

Base Card with 1x Loop Driver mounted onto a Chassis Plate

Door with Display Card mounted onto a fascia plate. Key-Lock.

Option for eight key-switches or four key-switches and a printer.

Option for a 50-Zone LED card.

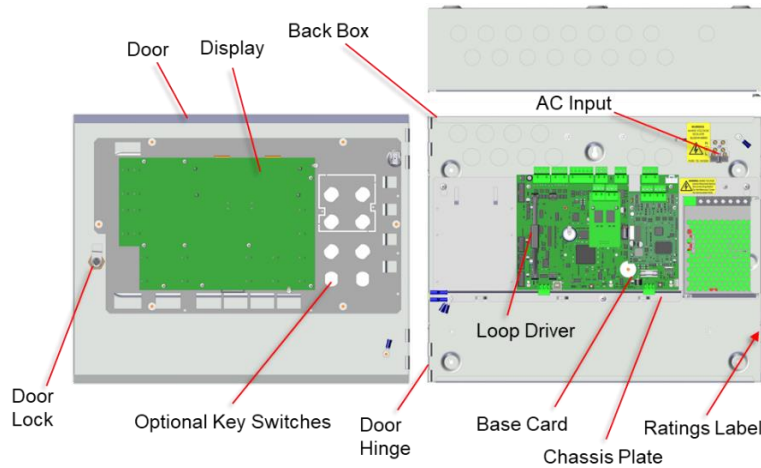

##### /L Enclosure comprises:

Back Box

Base Card with 1x Loop Driver mounted onto a Chassis Plate

Door with Display Card mounted onto a fascia plate. Key-Lock.

Option for eight key-switches or four key-switches and a printer.

Option for two 50-Zone LED cards.

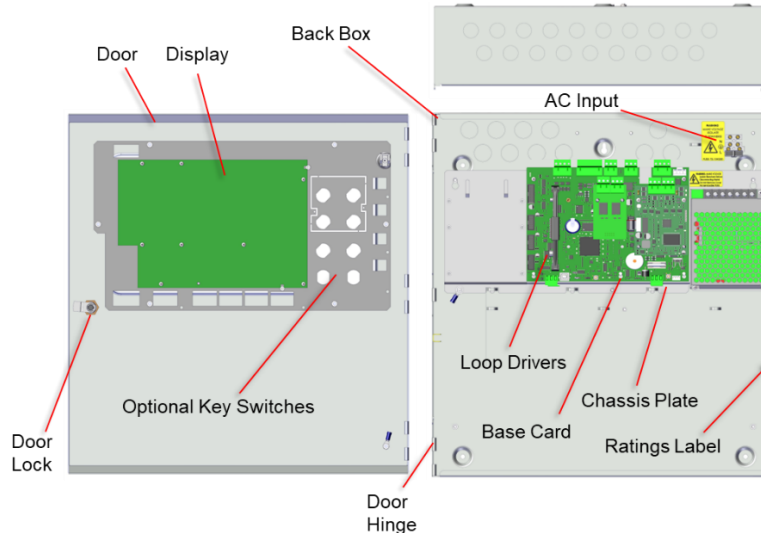

## 2.1.2 HS-5200

### /M Enclosure comprises:

Back Box

Base Card with 2x Loop Drivers mounted onto a Chassis Plate

Door with Display Card mounted onto a fascia plate. Key-Lock.

Option for eight key-switches or four key-switches and a printer.

Option for a 50-Zone LED card.

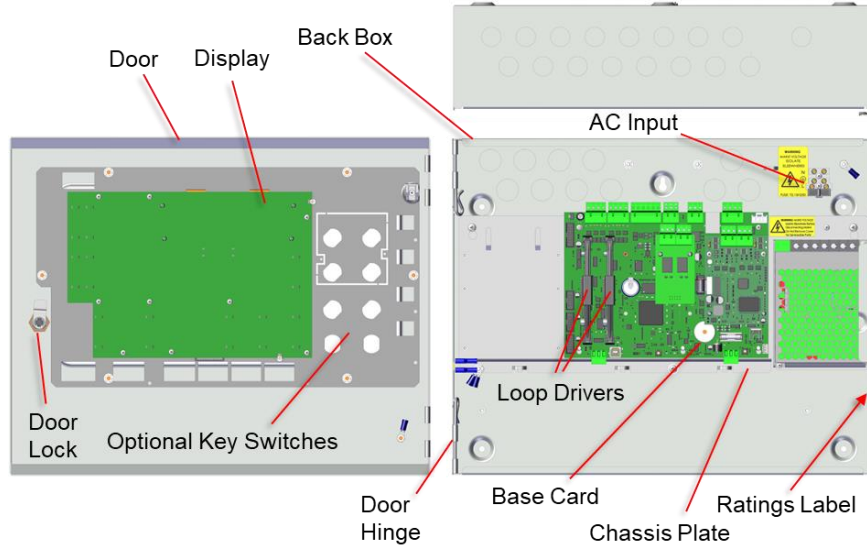

### /L, /D Enclosures comprises:

Back Box

Base Card with 2x Loop Drivers mounted onto a Chassis Plate

Door with Display Card mounted onto a fascia plate. Key-Lock.

Option for eight key-switches or four key-switches and a printer.

Option for two 50-Zone LED cards.

The deep (/D) enclosure arrangement is identical.

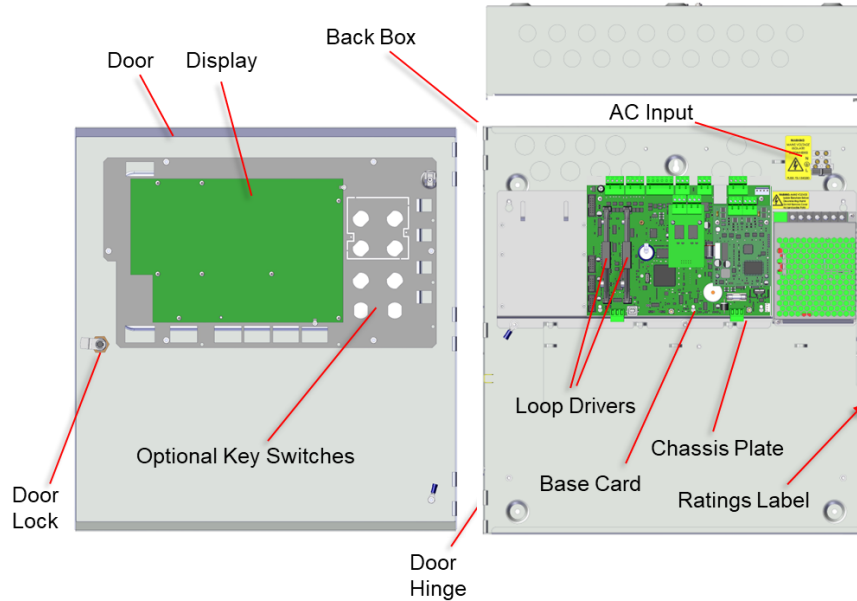

### 2.1.3 HS-5400

#### /L, /D Enclosures comprises:

Back Box

Base Card with 1-4 Loop Drivers mounted onto a Chassis Plate

Door with Display Card mounted onto a fascia plate. Key-Lock.

Option for eight key-switches or four key-switches and a printer.

Option for two 50-Zone LED cards.

The deep (/D) enclosure arrangement is identical.

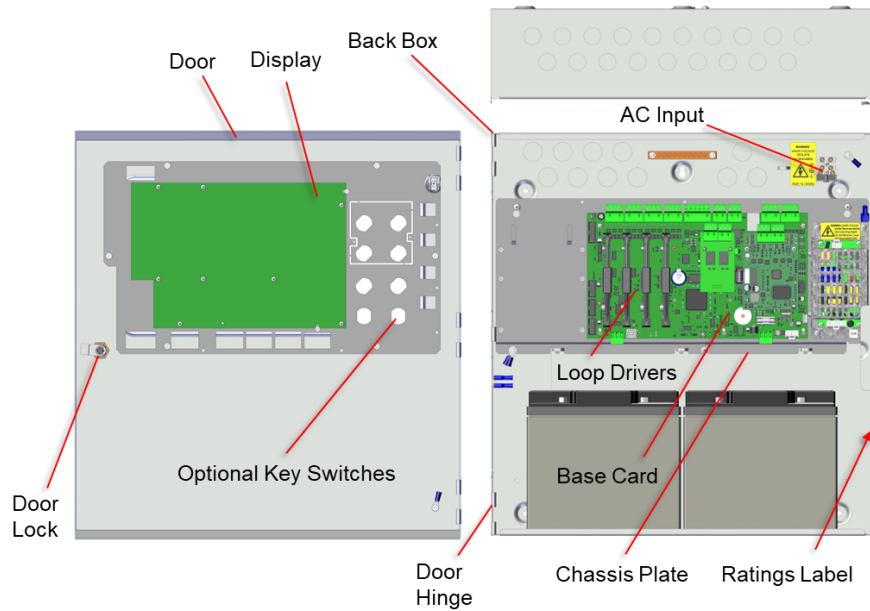

### 2.1.4 HS-5800

#### /E Enclosures comprises:

Back Box

Door with Display Card mounted onto a fascia plate. Key-Lock (2).

Option for eight key-switches or four key-switches and a printer.

Option for HSP-513-XXX LED cards fitted to door.

The HS-5800 consists of two independent systems comprising of 4-LP Base Cards and Display Cards (only one display is normally visible) and each system capable of supporting 512 detection devices.

Network cards are fitted as standard and wired internally. Additional information on networking is detailed in document HS680-502.

For redundancy of indications and controls, install an MX-5010 or 5020 Remote Terminal.

For redundancy of parent functions (i.e. Fire Alarm Routing, Fire Brigade Terminals, etc.) install these with redundant connection from each chassis using the appropriate interfaces.

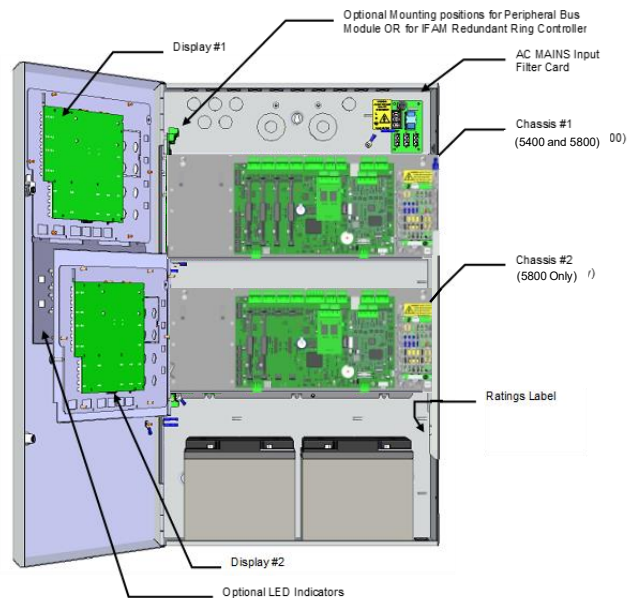

HS-5400E arrangement is identical but without Chassis #2 and Display #2.

For more information see document HS680-208

## 2.2 Installing the Enclosure



The panel is heavy when the batteries are installed. Use the appropriate fixing hardware to secure the panel to the wall. Observe recommended lifting practices to guard against spinal injury. See table below for maximum weights.

Enclosure	Weight	Maximum Battery	Overall Maximum Weight
/S (Small)	6Kg	7Ah 2.5Kg	11Kg
/M (Medium)	8Kg	12Ah 3.9Kg	16Kg
/L (Large)	10Kg	18Ah 5.7Kg	22Kg
/D (Large/Deep)	12Kg	45Ah 15.5Kg	43Kg

### 2.2.1 Opening the Enclosure Cover

The enclosure covers are provided with a key-lock assembly for securing the hinged door to the back box. Insert and turn the key anti-clockwise to open the enclosure.

### 2.2.2 Removing the Chassis

It is recommended that the chassis be removed before fitting the panel to the wall. To remove the chassis:

Disconnect the earth cable connecting the chassis to the spade terminal on the rear enclosure.

Unplug the 3-way connector feeding the AC supply to the Base Card.

Disconnect the ribbon cable connecting the display to the base card at the display.

Loosen the two screws holding the chassis to the back box. There is no need to remove these screws fully – the chassis plate has keyhole style mounting holes. Carefully remove the chassis from the rear enclosure and place in a safe place to prevent accidental damage.



**Do not lift the chassis by holding onto any of the printed circuit cards. Hold the chassis by the metal plate only.**

### 2.2.3 Mounting the Enclosure

Firstly, remove the required knockouts for the installation wiring. There are sufficient knockouts on the top of the enclosure for all installation wiring. In addition, there are knockouts at the top of the back wall, if required, for rear entry cabling.

The enclosure is provided with three fixing points.

The diagrams opposite and below show the positions of the three holes and dimensions of each enclosure. Use all three positions to ensure the panel is held securely to the wall.

Ensure the wall / structure is suitable for mounting the panel and there is sufficient space to allow the door to be opened when the panel is mounted.

Ensure the wall and fixings are capable of supporting the weight of the panel including batteries.

E.g. For a solid wall drill the required holes in the supporting wall using a 7.0 mm Ø drill bit and plug with a suitable 40mm or longer expansion plugs. Affix the panel to the wall with M5 x 40mm screws.

Use a brush to remove any dust or swarf from the enclosure before you install the chassis.

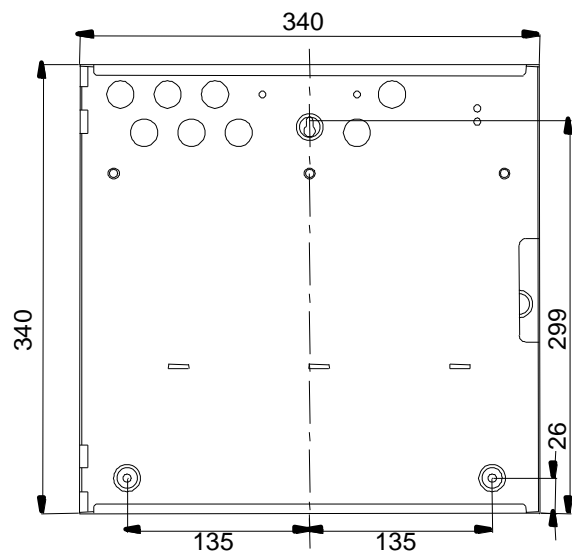

(/S) Enclosure Size and Fixing Point Dimensions

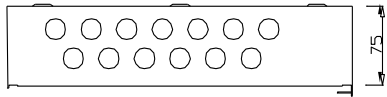

(/S) Enclosure Size and knockouts (top)

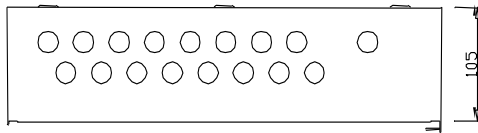

(/M) Enclosure Size and knockouts (top)

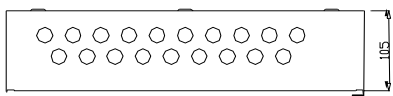

(/L) Enclosure Size and knockouts (top)

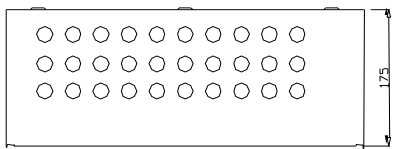

(/D) Enclosure Size and knockouts (top)

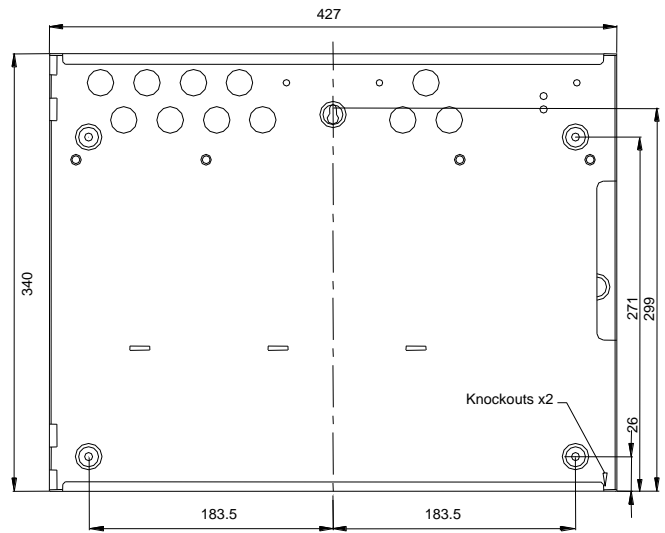

(/M) Enclosure Size and Fixing Point Dimensions

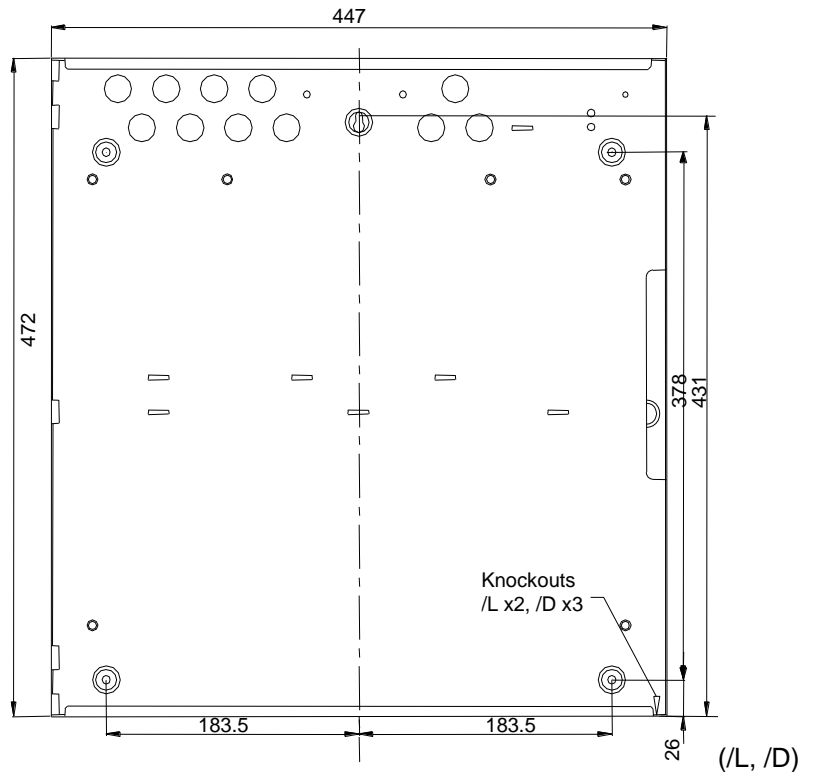

Enclosure Size and Fixing Point Dimensions

(/L, /D)

## 2.2.4 Install the Chassis

Carefully replace the chassis and fix into place using the two screws.

Reconnect the chassis earth cable to the spade terminal in the rear of the enclosure, reconnect the display cable to the display card and then reconnect the AC supply lead to the Base Card.

### 2.2.5 Recommended Cable Routing Arrangement

It is recommended that the typical routing arrangement shown in the diagram opposite be employed.

Segregate the low voltage wiring (Loop Circuit, Sounder Circuits and AUX Supply) from the AC Mains Wiring.

Segregate any wiring connected to the relay contacts.

Refer to **Appendix 2 – Recommended Fire Rated Cables** for further information on cable types to be used.

Refer to specific sections on how to install AC Mains input and loop, sounder, relay and AUX outputs circuits.

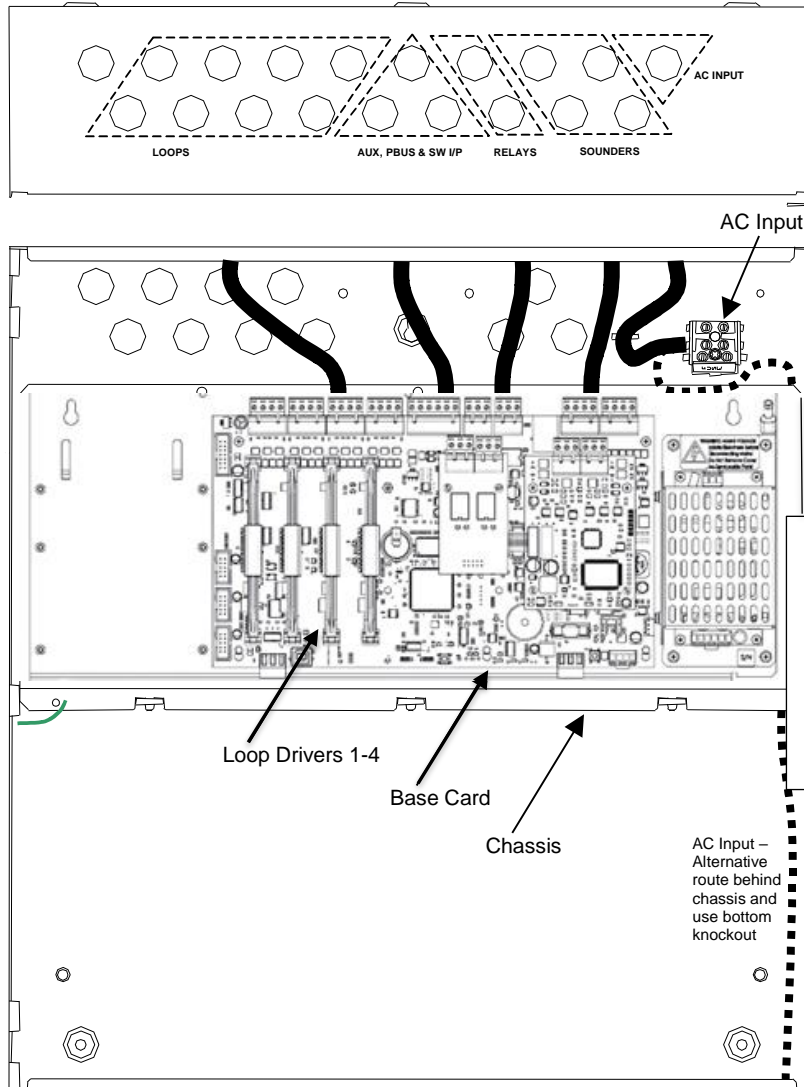

Internal arrangement showing recommended routing of cables.

### 2.3 Loop Driver Installation

The HS-5100 panels are factory fitted with one loop driver.

The HS-5200 panels can be fitted with up to two loop drivers – factory fitted with at least one loop driver.

The HS-5400 panels can be fitted with up to four loop drivers – factory fitted with at least one loop driver.

### 2.3.1 Fitting the cards

To extend the number of detector loops or to replace an existing loop driver card follow the procedure described below.

Examples of the loop drivers are shown opposite. These cards are populated with components on both sides of the cards – the main side view is shown for both examples.



**Isolate ALL sources of power before installing or removing printed circuit boards.**



**Observe anti-static precautions at all times when handling printed circuit boards.**

A section of the Base Card identifying the locations for each loop driver is shown in the pictures below.

To install a loop driver, operate the locking tabs of the card guides, then gently guide the loop driver printed circuit card into the card guide slots and then push into place onto the connector on the Base Card.

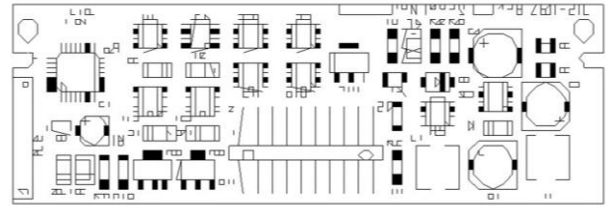

Loop Driver – Main Component Side View

Ensure that the pins of the connectors are correctly aligned. The loop driver should be inserted with the main component side of the board placed on the left-hand side. The Base Card can accept from one up to four loop driver cards – it does not matter which positions are used. Ensure that the detector loop wiring is made to the terminal block positions appropriate to the loop driver cards actually installed.

1-Loop Card

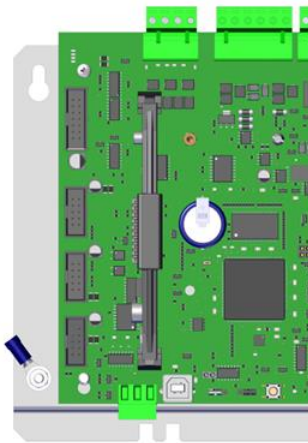

2-Loop Card

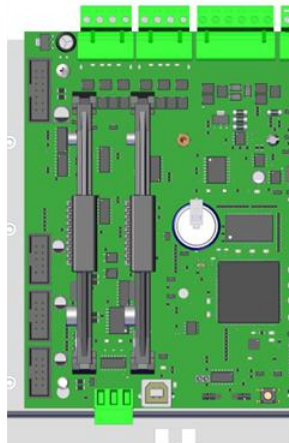

4-Loop Card

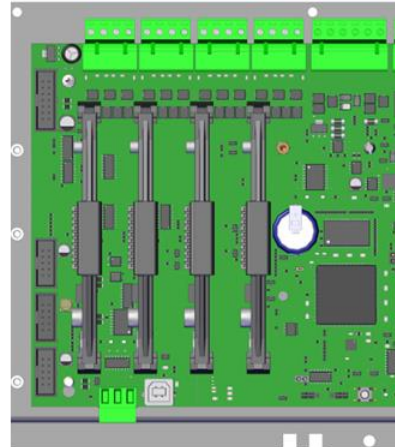

Loop positions are numbered 1 – 4 from the left hand side.

### 2.3.2 Removing a Loop Driver Card

To remove a loop driver, remove all power and follow the procedure above but:

Take a firm hold of top of the loop driver card. Gradually and carefully pull the loop driver vertically away from the base card and guide it out of the slots in the card guides.

## 2.4 Plug-In / Peripheral Bus Modules

All panels provide provision for installation / use of local peripheral cards to provide additional functions. The peripherals are connected via an isolated bus interface.

Each panel supports either a plug-in 2-Way Relay card or a plug-in General Routing Interface card (peripheral bus module).



All panels also support the connection of up to sixteen MXP-034 4-Way Programmable Sounder Modules <sup>5</sup>, up to sixteen MXP-035 4-Way Programmable Relay Modules and other peripheral bus modules housed in separate enclosures. All panels except the small enclosure (/S) support the mounting of one peripheral module on the chassis plate.

Refer to the wiring installation section (2.5.8) for details of how to connect the peripheral modules and section (2.5.5) for details of the network connections.

### 2.4.1 Routing Interface Card (Plug-In)



**Outputs to Routing Equipment – Clauses 7.9 and 8.9.**

**Output to Fire Protection Equipment – Clause 7.10**

**The Routing Interface Card provides monitored outputs for connection to Fire Routing Equipment (Item E) and Fault Routing Equipment (Item J) or to Fire Protection Equipment (Item G) in accordance with EN54-2.**

The MXP-532 Interface card is fitted to the base card using 1x M3 screw and 3x plastic pillars. A metal pillar is pre-fitted to the base card. Refer to the diagram opposite.

All signals and power required for operation of the card are provided on the plug-in connections.

Ensure that the connections are correctly aligned.

The screw fixing is essential for EMC Immunity protection.

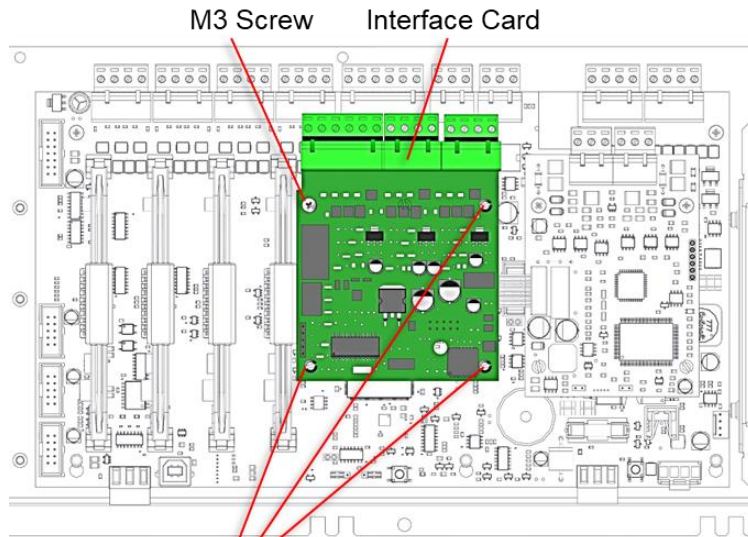

Plastic Spacers  
Mounting Position for the Routing Interface Card



**Isolate ALL sources of power before installing or removing printed circuit boards.**



**Observe anti-static precautions at all times when handling printed circuit boards.**

<sup>5</sup> The MXP-034 and MXP-035 modules must be configured using the PC CONFIG TOOL. A maximum of 32 modules (of any type) can be connected only. Refer to the installation guides provided with each module for further details.

### 2.4.2 2-Way Relay Card (Plug-In)

The MXP-507 Relay card is fitted to the base card using 2x plastic pillars. Refer to the diagram opposite.

All signals and power required for operation of the card are provided on the plug-in connections.

Ensure that the connections are correctly aligned.

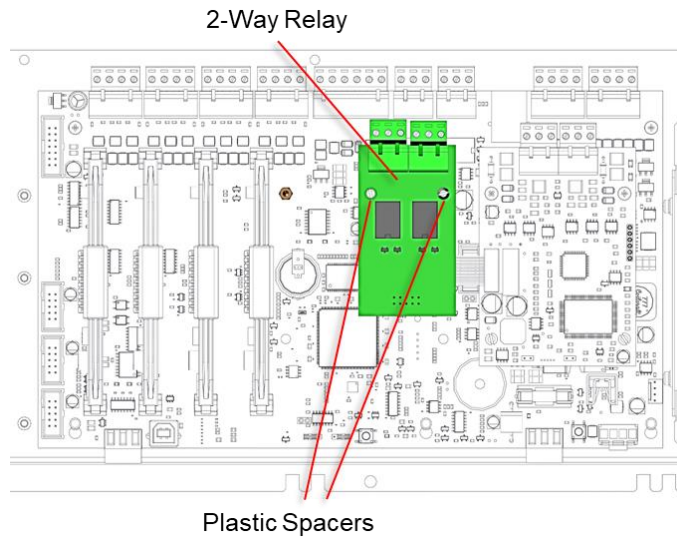

Mounting Position for the 2-Way Relay Card



**Isolate ALL sources of power before installing or removing printed circuit boards.**



**Observe anti-static precautions at all times when handling printed circuit boards.**

### 2.4.3 Network Card

An MXP-503 (STD) or an MXP-509 (FT) Network Card can be installed onto the base card.

The card is fitted to the base card using 1x M3 screw and 3x plastic pillars. A metal pillar is pre-fitted to the base card. Refer to the diagram opposite.

All signals and power required for operation of the card are provided on the plug-in connections.

Plug the ribbon cable into the connector as shown.

The screw fixing is essential for EMC Immunity protection.

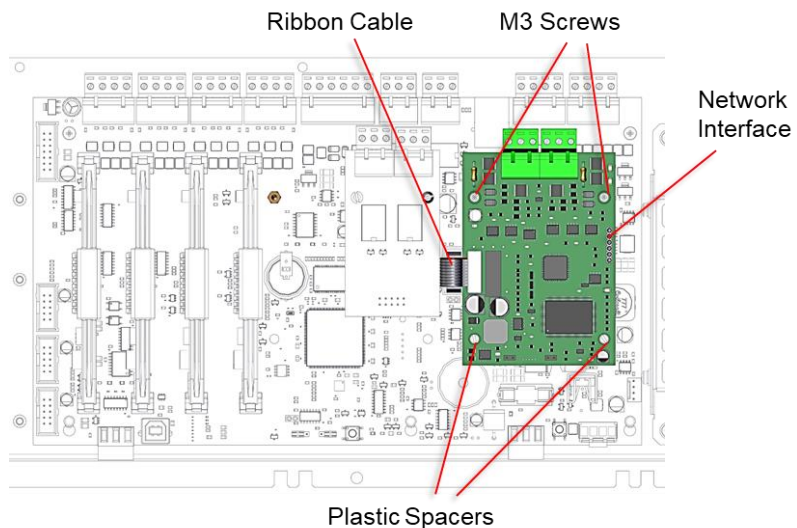

Mounting Position for the Network Card



**Isolate ALL sources of power before installing or removing printed circuit boards.**



**Observe anti-static precautions at all times when handling printed circuit boards.**

### 2.4.4 Peripheral Module Chassis Mounting

A Peripheral Module can be installed onto the chassis plate in the medium, large and deep enclosures.

The peripheral card is fitted to the chassis using 4x M3 screws.

All cards require connections to a 24V DC supply (AUX 24V) and to the PBUS communications. Refer to wiring section for further information.

The screw fixing is essential for EMC Immunity protection.

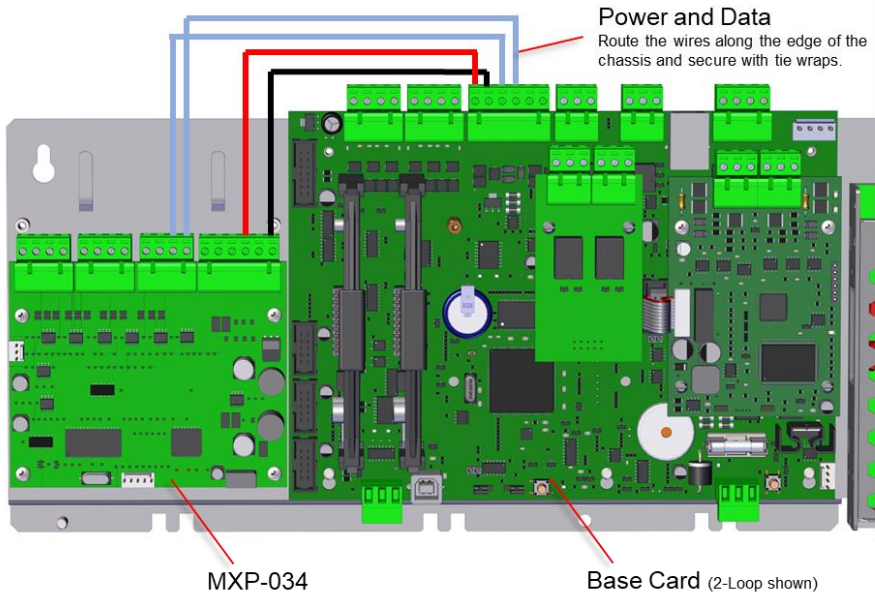

Mounting Position on Chassis – MXP-034 4-Way Sounder shown.



**Isolate ALL sources of power before installing or removing printed circuit boards.**



**Observe anti-static precautions at all times when handling printed circuit boards.**

### 2.5 Wiring Installation

All electrical wiring installation work and equipment should be both appropriately rated and approved, and carried out in accordance with the regulations, code of practice or applicable national standards appropriate to the country of installation.

To maintain the electrical integrity of the SELV wiring on the input, output, loop and communications lines all SELV wiring should be segregated from the LV mains wiring and be wired using cable with insulation suitable for the application.

To minimise the effects of EMC interference all data wiring circuits should be wired with a twisted pair of conductors with a cross sectional area suitable for the loading conditions.

In areas where cabling may come into contact with high frequency interference, such as portable radio transceivers etc. the data wiring cable should be of a twisted pair construction within an overall screen. Care should be taken to correctly terminate this screen, refer to the appropriate sections of this manual for further information for each circuit type.

NB: Minimum / Maximum cable size for all external connections is limited to 0.5mm<sup>2</sup> / 2.5mm<sup>2</sup> (22-14AWG).

## 2.5.1 AC Mains Wiring

Route the high voltage mains AC wiring into the enclosure at the upper right corner only. Keep the AC wiring away from the circuit boards and all other wiring.



The panels must be connected to the supply earth through the power cable.

The mains input connector is shown in the diagram opposite. Note the positions of the earth, neutral and live terminal connections. These are clearly marked on the label next to the connector. The connector block contains an integral fuse holder.

Secure the mains input wiring by tie wrap as close to the terminal block as possible.

Connect the Control Panel to the mains supply via a readily accessible all pole Live and Neutral disconnect-device. (Isolation Switch or circuit breaker) and a permanently connected protective earth conductor to the building installation wiring..

The disconnection device must be clearly marked - e.g. "Fire Alarm Do Not Switch Off"

The Mains cable should be a minimum 0.75mm<sup>2</sup> cable rated at 250V and fused via a 5A anti-surge fuse.

### MXP-514

An alternative power connector is used on the HS-5800.

The cables are supplied with the module for connection to individual power supply inputs

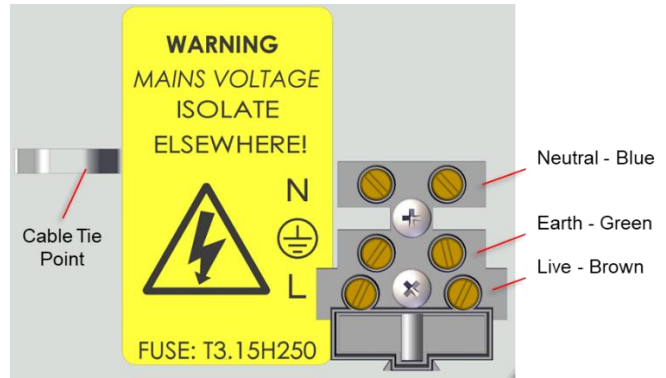

AC Mains terminations

The fuse is rated as follows:

- T 3.15A H 250V

Replace with correct rating and specification only.

### MXP-514

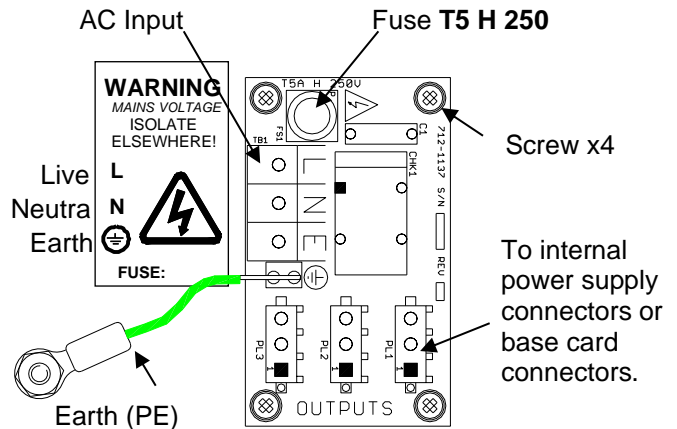

### 2.5.1.1 Cable Gland



The cable gland and any cord clamp bushings used in routing the Mains cable through the 20mm knockout must have a minimum flame-retardant rating of UL94 V-1.

## 2.5.2 Battery Installation



**Risk of Explosion if the battery is replaced by an incorrect type.**  
Refer to Section 4.2.1.1 for a list of recommended batteries

**Risk of burns and explosion. Do Not Short Circuit Battery Terminals or Battery Leads**

The panel requires two 12V batteries for standby operation.

The battery leads are connected onto the base card via a two-part plug and socket, as shown in the diagram opposite.

Refer to the Specifications for minimum and maximum battery sizes allowed.

Note: Either of the positive connections can be used on the terminal block.

### Base Card Terminations

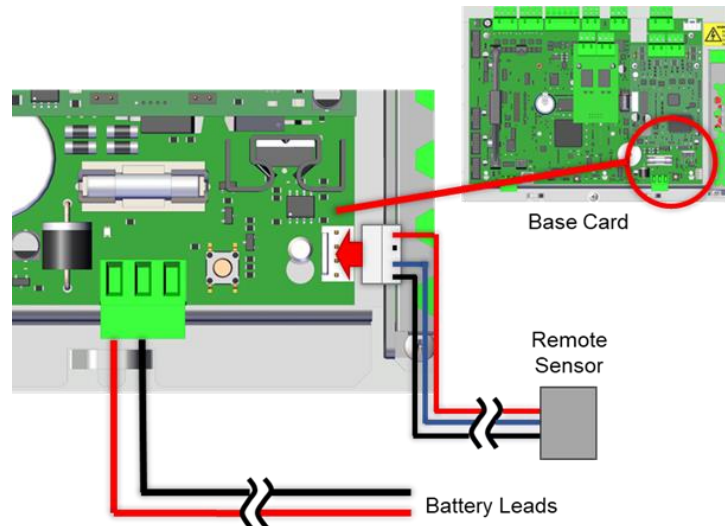

**Observe the polarity of battery connections.**

**Do not make the final battery connections until the installation wiring is completed and the system is to be powered up.**

**Always connect the AC Mains input before connecting the battery.**

**New batteries require 'top-charging' before installation. Refer to Section 4.2.1.1 for a list of recommended batteries.**

Ensure that the battery terminals do not short out against any part of the enclosure, circuit board or chassis plate.

To prevent short circuits terminate the battery cables and batteries as follows. Connection to the circuit board should be made last.

1. Terminate the red battery lead to the +ve and the black battery lead to the -ve terminals of the 3 way battery connector (either of the +ve terminals can be used).
2. Fit the fused link from +ve terminal on battery one to the -ve terminal on battery two
3. Connect the black -ve battery lead to the -ve terminal on battery one
4. Connect the red +ve battery lead to the +ve terminal on battery two
5. Plug in the 3 way battery connector to PCB.

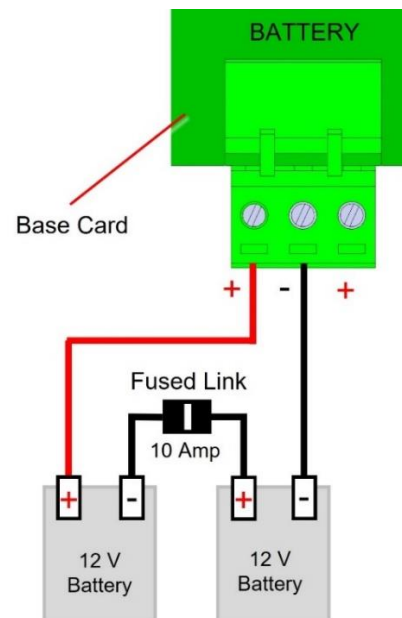

2.5.2.1 Small Enclosure

The diagram opposite shows the recommended location and orientation for the 7AH batteries within the panel.

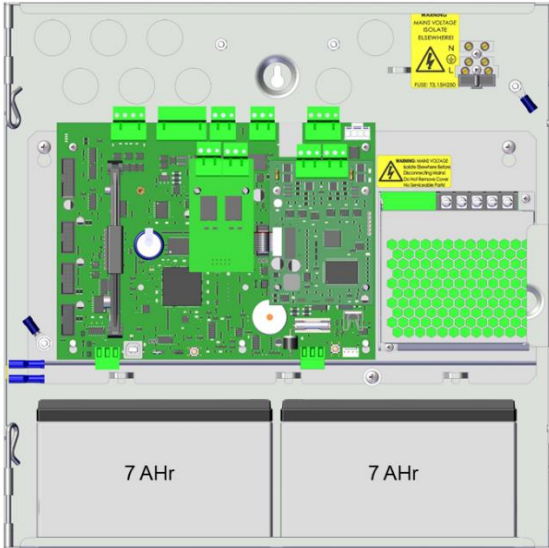

2.5.2.2 Medium Enclosure

The diagrams opposite show the recommended location and orientation for 7Ah – 12AH batteries within the panel.

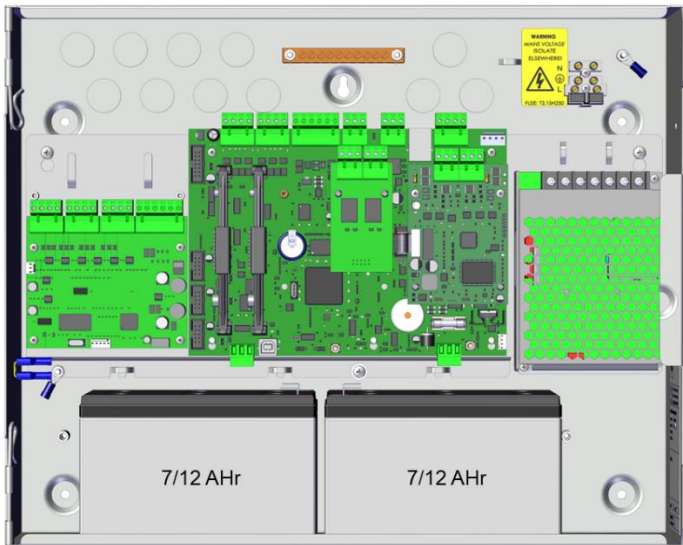

### 2.5.2.3 Large Enclosure

The diagrams opposite show the recommended location and orientation for 7Ah – 17AH batteries within the panel.

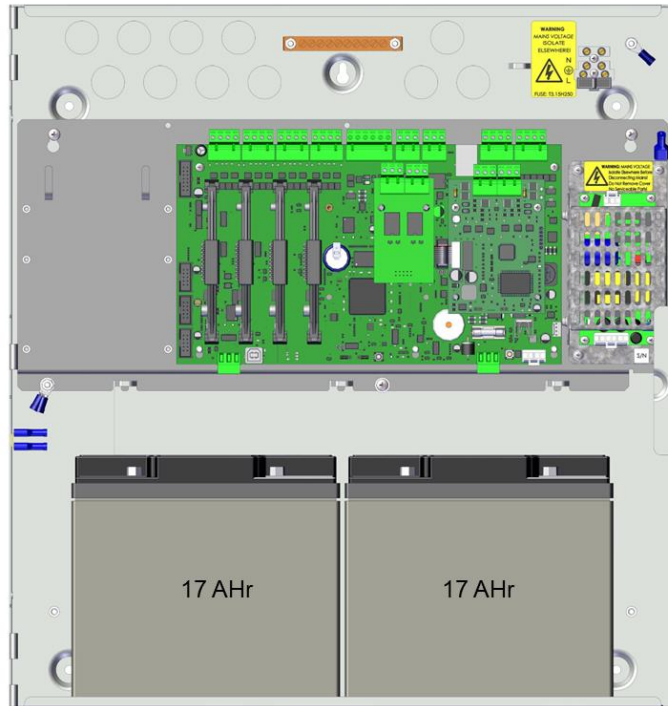

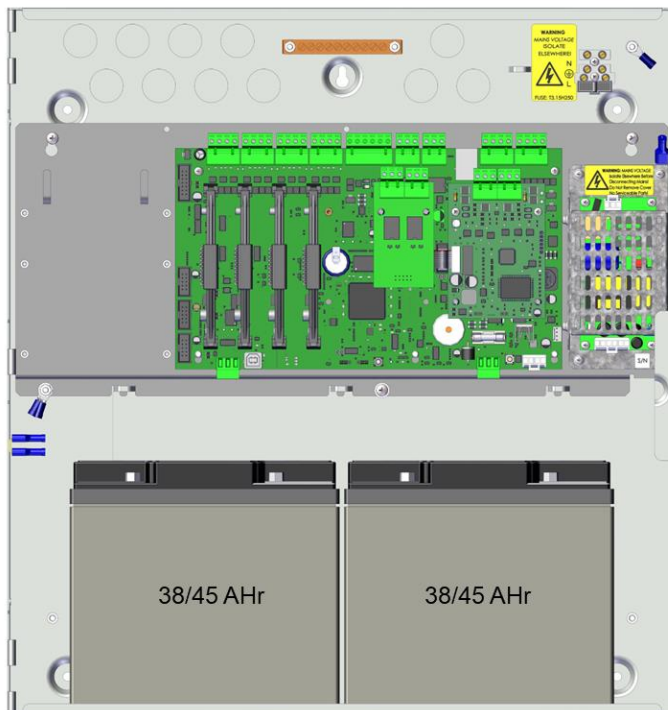

### 2.5.2.4 Deep Enclosure

The diagrams opposite show the recommended location and orientation for 7Ah – 38AH/45AH batteries within the panel.



### 2.5.3 Detector Loop Installation

 <p><b>Section 12.5.2</b></p>	<p><b>Maximum of 32 Sensors / Call Points in a Zone (between Isolators).</b></p> <p>The Detection Loop Circuit should be installed as a continuous loop with isolator modules such that a short circuit condition does not remove more than one zone or 32 input devices or affect more than one function.</p>
 <p><b>Section 13.7</b></p>	<p><b>Not more than 512 fire detectors and / or manual call points and their associated mandatory functions shall be affected because of a system fault in the C.I.E.</b></p> <p><b>No more than 512 fire input devices per panel. For installations &gt; 512 devices, fire routing shall be via redundant connection – see 2.5.12, and see Appendix 6 for further details on network installations.</b></p>

Form the loop starting at the Loop Out + and – terminals on the base card.

Route the wires around the loop connecting all devices in accordance with the manufacturers' data sheet supplied with each unit.

Ensure that the devices are correctly installed with regard to their positive and negative terminal polarity (especially Loop Isolator Modules).

Connect the return wires to the Loop IN + and – terminals on the base card.

The diagram opposite shows the typical arrangement of the loop connections on the base cards.

Refer to Section 2.3 for details on installing additional loop drivers on the multi-loop panels.

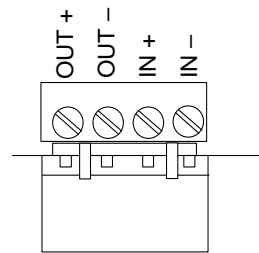

Base Card Terminations (Typical).



*When screened cable is used, it is vital to connect the screen / drain wire to the chassis / earth at the cable gland input / earth stud in the panel. Always ensure that all segments of the cable loop have continuity of the screen and take care to ensure that the screen is not exposed to any other earth point (e.g. metalwork, cable trays, junction boxes, etc.).*

The Loop Driver Circuit on the Base card is equipped with in-built isolators to take care of short circuit conditions on the wiring between the panel and the first device on the loop. Do not fit loop isolators at the panel outputs.

The diagram opposite shows a typical loop arrangement.

Maximum recommended cable loop length is 1500 to 2000 Metres. Refer to **Appendix 2 – Recommended Fire Rated Cables** for further information on cable types to be used.

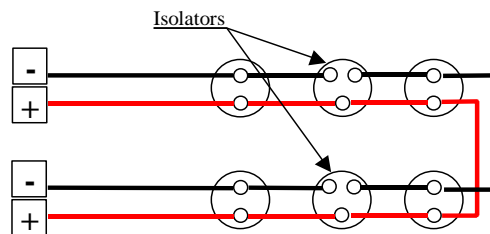

Typical Loop Arrangement.



*Take care that the voltage drop at full load is within the detector rating – refer to the detector manufacturers' data sheet for minimum values.*

*To maintain signal line wiring supervision, break the wiring run at each loop device.*



The loop circuits support monitoring with an Active EOL device (embedded on the loop driver) to ensure circuit integrity in accordance with the requirements of EN54-13.



## 2.5.4 Sounder Circuits

The HS-5100 & HS-5200 are equipped with two supervised sounder circuits. These are denoted as Circuits A and B.

The HS-5400 is equipped with four supervised sounder circuits. These are denoted as Circuits A, B, C and D.

Each Sounder output is rated at a maximum of 1 Ampere.

The terminal connections on the base card are shown in the diagram opposite.

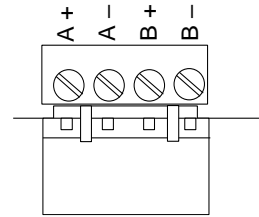

Base Card Connections – Typical.

The sounder outputs are monitored (supervised) for open and short circuit conditions using reverse polarity signals. Sounder must be equipped with an in-built blocking diode that prevents the sounder from taking power when the output is in the supervising condition.

An End-of-Line Resistor (EOLR) of value 6200Ω, ½ Watt must be fitted to the last sounder / bell. Refer to **Appendix 2 – Recommended Fire Rated Cables** for further information on cable types to be used.

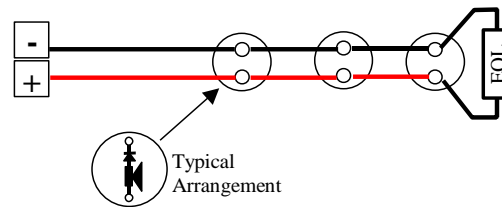

Typical Sounder Arrangement.



*When screened cable is used, it is vital to connect the screen to the chassis / earth at the cable gland input / earth stud in the panel. Always ensure that all segments of the cable loop have continuity of the screen and take care to ensure that the screen is not exposed to any other earth point (e.g. metalwork, cable trays, junction boxes, etc.).*



The sounder outputs support monitoring with an Active EOL device to ensure circuit integrity in accordance with the requirements of EN54-13.

The sounder circuits can be configured for compliance with EN54-13 by programming and the use of an Active EOL device. All panel sounder outputs must be fitted with the Active EOL device (MXP-505)

The panel uses techniques to ensure that a fault warning condition is reported if the circuit resistance increases to a condition where the voltage at the last device may fall below its minimum operating voltage level. This is compatible for load currents from minimum up to maximum (1 ampere).

Install the Active EOL device at the end of the sounder circuit instead of the normal EOL resistor – this device is polarity sensitive. Connect the Red lead to the sounder + signal line.

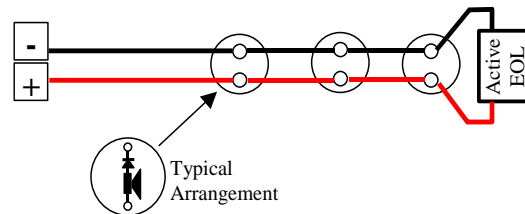

Typical Sounder Arrangement.

### OBSERVE POLARITY

**The Active EOL device is polarity sensitive.**

**The Active EOL is fuse protected – however, if connected incorrectly and the sounder circuit is activated, the fuse will open and is not user replaceable.**



## 2.5.5 Network Interface

The network permits the connection of other panels, remote terminals and other devices to complete a distributed system.

Either an MXP-503 (STD) standard network interface card or an MXP-509 (FT) fault tolerant network interface card must be installed in the panel. All network nodes must be installed with the same type of interface.

Cable must be twisted pair 18AWG or 20AWG.

Screened type cable is recommended (e.g. Belden 8760, 8762). Connect the screen to the designated terminal block positions only.

Each interface card has independent connectors for the outgoing and incoming network cable. Using a twisted-pair cable, connect from the "OUT" socket on the first panel to the "IN" socket on the next panel as follows.

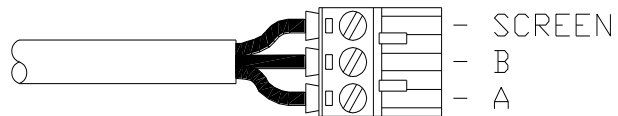
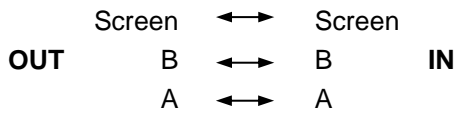
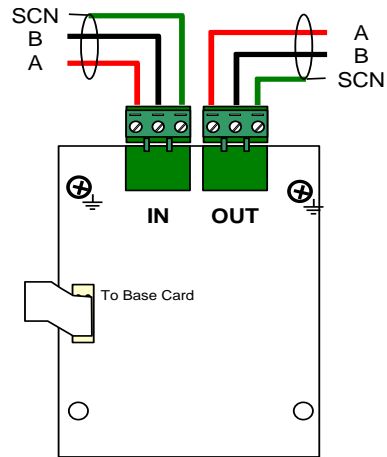

### STD (Up to 32 nodes)

The "IN" terminals on the first node and the "OUT" terminals on the last node are not used. Connect an ELR (150Ω) resistor between A and B on the terminal blocks of the unused sockets.

Maximum cable length (overall length) is 1500m using recommended cables.

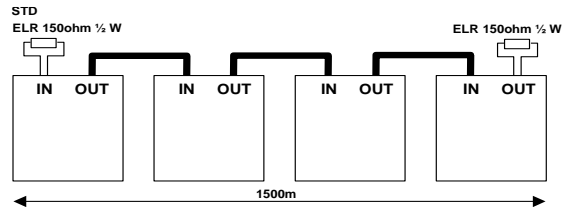

### FT (Up to 200 nodes)

Other Network devices must be fitted with a FT type adaptor card.

Install a cable from the last node "OUT" terminals back to the first node "IN" terminals to form a ring.

Maximum cable length between nodes is 1500m using recommended cables. Maximum cable length (overall length) is 20000m using recommended cables.

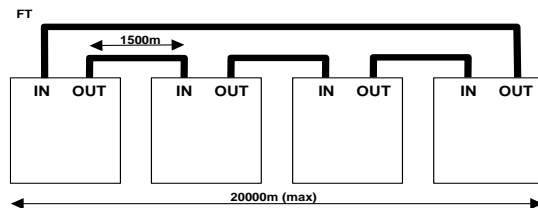

## 2.5.6 Relay Circuits

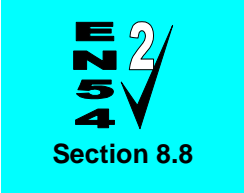

**Fault Output.**

**Relay 1 is arranged for failsafe operation as standard.**

The *HS-5000 Series* are equipped with two relay outputs. These are normally programmed to activate on Fault and Fire Alarm conditions respectively.

Each output is unsupervised with volt-free changeover contacts rated at 30V AC/DC, 1 Ampere, resistive.

An Optional plug-in 2-Way relay card is available if additional relays are required (Relays 3 & 4).

Optional peripheral bus relays cards are also available.

The Relay outputs can be used, instead of the Routing Interface Card, to provide non-monitored fire and fault routing outputs to appropriate routing equipment.

In this case, the panel will not indicate transmission path failures to the routing equipment – this feature must be incorporated into the routing equipment itself. [Not fully EN54-2 compliant].

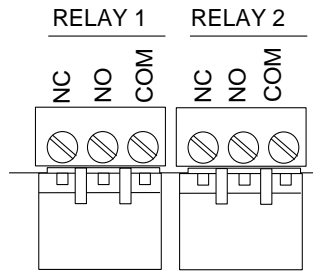

Base card connections

## 2.5.7 Auxiliary Supply Output

The *HS-5000 Series* are equipped with an auxiliary 24V DC, 500mA power supply output.

This can be used for powering ancillary equipment and must only be used for powering localised / internal equipment.

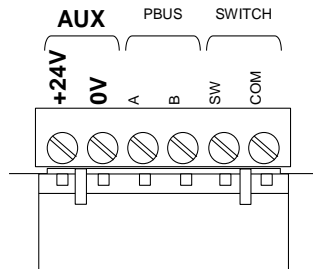

Base Card connections

## 2.5.8 Isolated Peripheral Bus Interface

The isolated bus interface is used to connect local peripheral equipment located internal to the panel or located within 10m of the panel.

The terminal block on the *HS-5000 Series* base card is shown opposite. Connect the cable from 'A' to 'A' and from 'B' to 'B'. Equipment is connected via a daisy chain.

External connections should be made using fire rated cable or run in rigid metal conduit between enclosures.

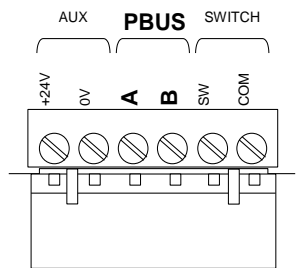

Base Card connections



Peripheral Bus modules must be configured using the PC Tool

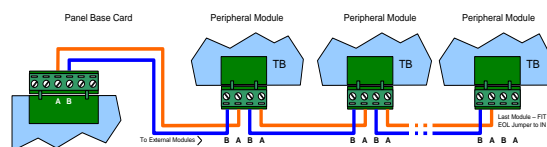

## 2.5.9 Switch Inputs

### 2.5.9.1 Base Card

One Switch input is provided on the base card (I/P9) and up to eight key switch inputs (I/P1-8) are provided on the display card.

These can be used for changing access level, performing “class change” etc. by changing the “Action” of these inputs.

Refer to separate Application Notes for examples.

The base card switch input is a monitored circuit –  
EOL = 3K3 Ω, Activation = 680 Ω

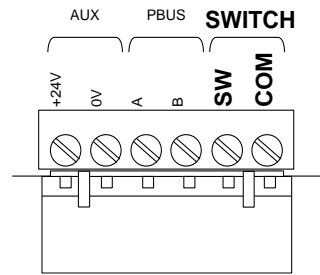

Base Card Connections.

### 2.5.9.2 Display Card

Optional key switches (volt-free) are available to be mounted on the panel fascia plate. These are pre-wired with the appropriate 2-pin connector.

Using a sharp knife, cut through the fascia label using the aperture profile as a template. Insert the switch mechanism and tighten the nut. Route the wiring as shown and plug into the connector.

Program the required function.

The fascia label is provided with a slide-in label pocket for a user text description.

The switch cable connector plugs into the display card connector as shown opposite.

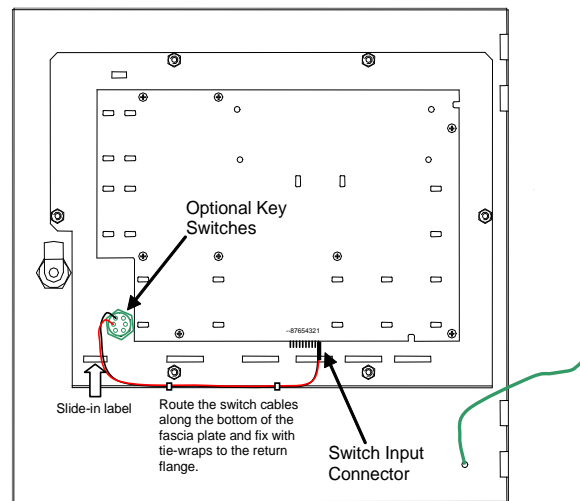
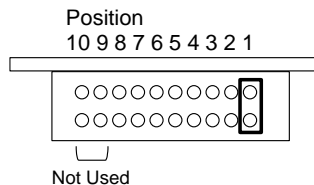

Display Plate Arrangement (Typical).

## 2.5.10 RS232 Interface

The *HS-5000 Series* are equipped with an isolated RS232 I/F Circuit at the bottom of the base card.

The terminal block connections are shown opposite.

TX = Transmit Data from the panel, RX = Receive Data into the panel, GND = Ground Reference.

This interface can be used for connection to a modem, pager interface, PC or external printer.

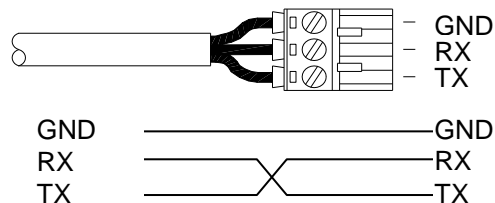

Base Card Connections – typical.

## 2.5.11 USB Interface (Type B)

The *HS-5000 Series* are equipped with an isolated USB I/F Circuit at the bottom left of the base card.

This can be used for connection to a PC for use of the PC Configuration Tool.

The USB Interface uses common signals with the RS232 Interface – plugging in a USB connection disconnects and isolates the RS232 Interface.

## 2.5.12 Routing Interface

**PC ONLY**

The Plug-In Routing Interface is used to output monitored signals to Fire Routing Equipment and Fault Routing Equipment or to Fire Protection Equipment.

### 2.5.12.1 Fire / Fault Routing

Each function comprises of an output circuit and an input (confirmatory) circuit.

Each output is monitored for open circuit and short circuit wiring conditions in both the activated and quiescent states and can be connected to a remote relay coil with a resistance of 1KΩ to 5KΩ. A suppression diode must be connected across the coil – observe connection polarities.

If an output is not used install a 1KΩ ½W resistor across its output terminals.

The Fault Output is normally energised during the quiescent condition – it will de-energise on any fault or on total loss of power.

Each associated input circuit is monitored for open circuit and short circuit conditions using an EOL resistor (3.3KΩ or 10KΩ).

The primary Fire Routing Circuit is automatically switched to a failsafe input should the panel suffer a system fault or total power failure. If required, this input should be connected to and driven by another fire routing output located on a separate panel.

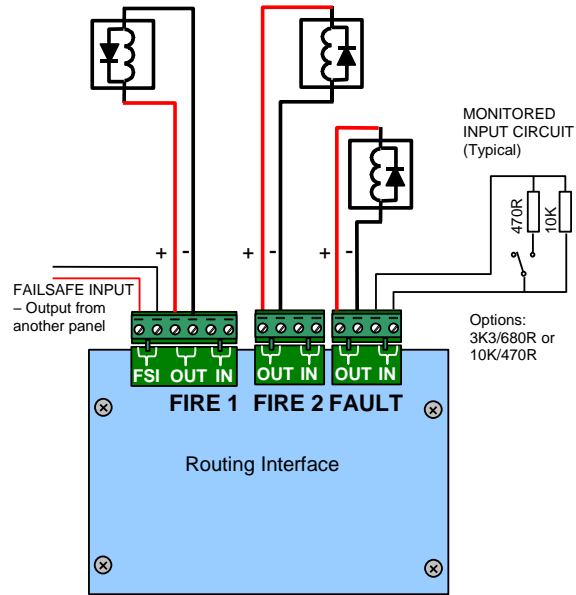

Typical Arrangement

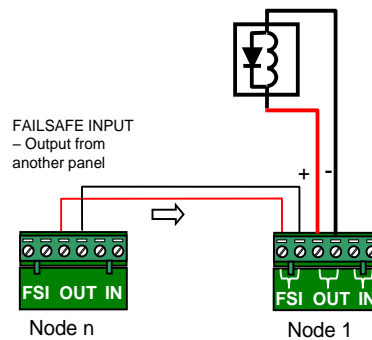

Fail Safe Arrangement

### 2.5.12.2 Fire Protection Routing

The Interface monitors the wiring to and from the Fire Protection function (i.e. Extinguishing panel).

A separate circuit card (MXP-506) is available to mount in the fire protection equipment to provide the required end of line relays for the output signals and end of line resistors for the return signals.

Typical functions are shown in the diagram opposite. The outputs are fully configurable in the software.

It is possible, for example, to provide two separate output release circuits where the fire protection equipment requires more than one physical activation signal.

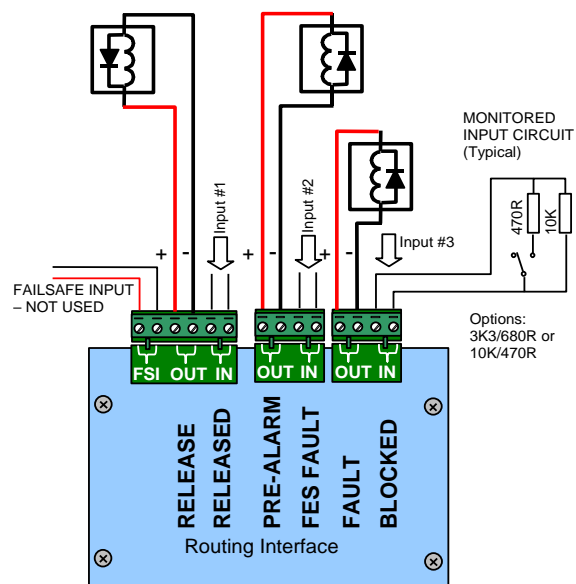

Typical Arrangement

Refer to [Appendix 2 – Recommended Fire Rated Cables](#) for further information on cable types to be used for these transmission paths.

## 3 Programming

### 3.1 Introduction



These instructions cover the configuration and programming of the panels.

Where you see the “PC Only” symbol, these features can either only be set-up using the PC Configuration Tool or there are additional options that are only available via the PC Configuration Tool.

#### 3.1.1 Access Levels

The panel operation is protected from inadvertent and erroneous misuse by means of four access levels. These levels are as follows:

Level 1 Untrained user

Level 2 Authorised User

Level 3 Commissioning, Service and Maintenance

Level 4 Commissioning, Service and Maintenance – Special Tools Required

This document covers the Level 3 functions. For details on the operation and use of the panel at Levels 1 & 2, refer to User Manual UI-ELAN-02. Full details are supplied with the special tools.

A level-3 password is required to enter the commissioning menus. For details of Passwords, refer to Section [3.3.13](#).



*Level-3 Passwords.*

*If this number is lost, it is not possible to enter commission mode functions.  
Refer to section [5.1](#) for further formation.*

*Default  
7654*

#### 3.1.2 Memory Lock

The configuration memory may be protected against inadvertent change by means of a memory lock.

Before making any configuration data changes, move the jumper strap to the OPEN  position.

After all changes have been made, move the jumper strap back to the CLOSE  position to protect the memory against inadvertent change.

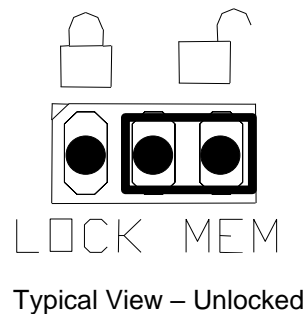

Refer to the diagram opposite for information on the jumper settings.

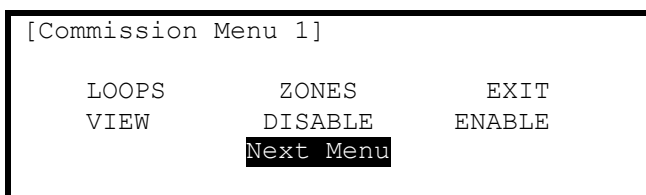

#### 3.1.3 Navigating through menus

The display will revert to status mode after 60s. Press the ‘Menu’ button to restore the display.



When a menu is displayed, use the  buttons to highlight the required menu option and then press the  button to select it.

Press the ‘Esc’ button from within a menu option to return to the previous menu.

The display can be forced back into status mode by pressing the 'Esc' button when at the top level commissioning menu (or by waiting 60s).

### 3.1.4 Changing Text Descriptions

Various parameters can have a text description defined. These include loop devices, zones, etc. The zone and device text descriptions will be shown on the display in the Fire Alarm, Fault and Warning Conditions, etc. to provide a quick and clear indication of the source of the problem.

To change the text description, first highlight the text description within the appropriate programming option and then press the ✓ button. The display then changes to show the text entry dialogue screen. For example:

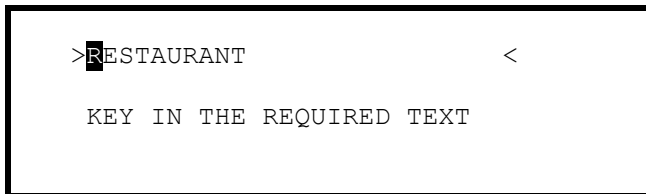

The method of entering the characters is similar to the method employed on mobile telephones. The number buttons provide both their appropriate number and several letters of the alphabet. An example of the keypad is shown opposite.

For example, Button 2 allows entry of the number 2 and letters A, B and C.

When a button is pressed, the first character is shown on the display at the current cursor position. If the button is pressed again within ½ second, the second character replaces the first. A further press displays the third available character and so on – see table below. After pressing the button to obtain the required character, wait for 1-second and the character will be entered and the cursor will move to the next character in the text description.

Pressing another button will immediately enter the previous character and move the cursor on to the next character.

Use the ←→ buttons to move backwards or forwards along the line. When the text description is as required, press the ✓ button to confirm the change.

If the text has been entered incorrectly, press the 'Esc' button to cancel all changes and return to the previous display.

The following table shows the numbers, characters and symbols assigned to each button on the keypad.

Button	1 <sup>st</sup> Press	2 <sup>nd</sup> Press	3 <sup>rd</sup> Press	4 <sup>th</sup> Press	5 <sup>th</sup> Press	Further Characters
1	1					
2	A	B	C	2		Ä, Æ, Å, À, Á, Â, Ã, Ç
3	D	E	F	3		È, É, Ê, Ë, Æ
4	G	H	I	4		Ì, Í, Î, Ï
5	J	K	L	5		
6	M	N	O	6		Ö, ø, Ò, Ó, Ô, Õ, Ñ
7	P	Q	R	S	7	
8	T	U	V	8		Ù, Ú, Û, Ü
9	W	X	Y	Z	9	Ý, Þ
0	Blank	0				

Alternatively, press the ↑↓ buttons to scroll through a list of characters. When the required character is shown, press the → button to move on to the next character. The list of characters available and the order of presentation is as follows:

Blank !"#%&'()\*+,-./ 0123456789 :;=<?@ ABCDEFGHIJKLMNOPQRSTUVWXYZ [ ] ^ \_

### 3.1.5 Numeric data entry

Numbers are entered by moving to the required field, and then typing in the required number, followed by the ✓ button.

If the number is entered incorrectly, press the ‘Esc’ button to restore the previous number.

### 3.2 Level 3 Menu Functions

The following table gives a list of the Level 3 Menu Functions, the sub-functions available within each main function and a brief description for each function. The menu options are available on three pages – select “Next Menu” to switch between pages.

Main Menu Option	Sub Menus	Comments		
3 4	LOOPS	View/Edit	View, test and configure the loop devices.	P A G E 1
		Auto Learn	Learn the Devices Present on the Loop.	
		Calibrate	Calibrates devices on the loop.	
		History	View historic information (last activation, last test, etc.) of each device.	
		Meter	View information on the driver circuit performance.	
		Scope <sup>6</sup>	View oscilloscope of driver circuit performance	
6	ZONES	--	Configure the Zone texts.	P A G E 2
	EXIT	--	Cancel Level 3 Access and return to Level 2 Menu Options.	
	DISABLE	7	Disable Zones/inputs, Outputs and Groups.	
	ENABLE	7	Enable Zones/Inputs, Outputs and Groups.	
	VIEW	Fires	View Zones and Inputs that are reporting a fire alarm condition.	
		Faults	View Zones and Inputs that are reporting a fault condition.	
		Alarms	View Zones and Inputs that are reporting an alarm condition during test.	
		Disabled	View Zones, Inputs and Outputs that are disabled.	
		Inputs	View the current state of Zones and Inputs.	
		Outputs	View the current operational condition of all output circuits.	
		Log	View the Event Log.	P A G E 3
		Panel	View the software of all installed components and the operational state, voltage & current loading of the panel I/O hardware.	
		Network	View Network Diagnostics.	
		Warnings	View Zones and Inputs that are reporting a warning condition	
		Supervisory	View Zones and Inputs that are reporting a supervisory condition	
2	PASSWORDS	--	Configure the Level 2 and Level 3 passwords.	
	TIME/DATE	--	Change the Date and Time Settings.	
	PC-CONFIG	--	Enable the PC Link for transfer of configuration data to and from the panel.	
	EN54-13	--	Configure the Operating Characteristics of the Output Circuits.	
1	SETUP	--	Configure General Operating Parameters.	
	DISPLAY	--	Adjust the display contrast setting	
	PANEL	--	View and configure all panel internal circuits.	
5	OUTPUT-GROUPS	--	Configure Output Group Cause and Effect Programming.	
	TEST	7	Test Zones, Display, Buzzer, Printer and Outputs.	

<sup>6</sup> Refer to separate application note on this function

<sup>7</sup> The operation of these menu functions are not described in this manual – refer to the User Manual for further information.



### 3.3 Recommended Programming Procedure

The main programming steps required will necessarily be different for each installation. However, the following is the minimum recommended.

- ◆ Step 1 – SET-UP, Define General Set-up Information (Phone Numbers, etc.).
- ◆ Step 2 – PASSWORDS, Define Level 2 and Level 3 Passwords as required.
- ◆ Step 3 – AUTO-LEARN, Let the panel learn the devices on the loop(s).
- ◆ Step 4 – VIEW DEVICES, Enter Zone Numbers, Location text and Change Group Assignments if required.
- ◆ Step 5 – OUTPUTS, Program Output Groups as required.
- ◆ Step 6 – ZONES, Enter Zone Texts as required.

#### 3.3.1 Loops

For Multi-loop panels only – On selecting the LOOPS option, the display will prompt for the loop to be viewed / programmed. For example: -

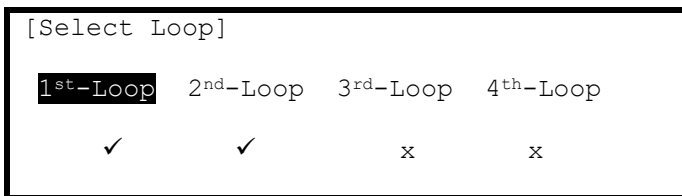

The list of loops available will be adjusted automatically to show only those loops that are available or have a loop driver card installed. In the above example, loop drivers are installed in positions 1 and 2 of an Mx-5400.

Press the **↑↓←→** buttons to scroll through the list of loops available and then press the **✓** button to select the loop required.

Note: For the HS-5100, and as there is only one possible circuit, the display will immediately show a list of programming options as follows:

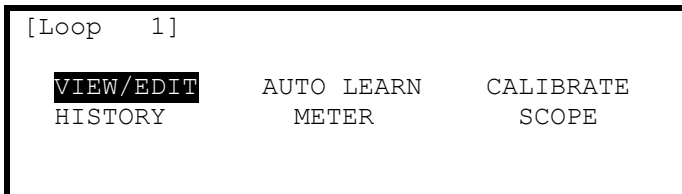

#### 3.3.2 Loops – View/Edit

The VIEW/EDIT option shows a list of the devices connected to the loop learnt by the panel. For example:

[Loop 1]			More>
Address	State	Type	Value
001.0	Normal	CALL POINT	16
002.0	Normal	MULTI.SENSOR	28
003.0	Normal	ION SMOKE	23
004.0	Normal	HEAT	21

The first device on the loop is shown at the top of the list and is highlighted. Press the **↑↓** buttons to scroll through the list of devices.

Press the **←→** buttons to view additional information. The display highlights a particular parameter. To change the value of this parameter (if not view only), press the **✓** button and appropriate options will be shown on the display. The address field is always shown for reference.

##### 3.3.2.1 State

This parameter shows the current operational status of the device. For example, this can show Normal, Fire Alarm, Device Missing, etc.

This parameter cannot be changed.

### 3.3.2.2 Type

This parameter shows the type of device learnt by the panel. For example, this can show Call Point, Multi-Sensor, ION Smoke, Heat, etc.

This parameter cannot be changed.

### 3.3.2.3 Value

This parameter shows the analogue value returned by the device. The number displayed will vary according to the type of device fitted. An 'H' (High) and 'L' (Low) is shown for logic inputs. This parameter cannot be changed. For specific device types, the mode of operation / sensitivity band is also shown.

### 3.3.2.4 Zone

This parameter shows the Zone to which this device has been assigned. Use the **number** keys to change the zone assigned to the device. Zones used must be unique to this panel.

### 3.3.2.5 Meldergruppe Number (MId)

The Meldergruppe number is only shown on panels for the German market (software specific feature). This is the assigned device number within the meldergruppe and can be in the range 1 – 32. Use the **number** keys to change the meldergruppe number assigned to the device.

### 3.3.2.6 Device Text

This parameter shows the 26-character location text assigned to this device. For guidance on how to change the text, refer to Section 3.1.4.

### 3.3.2.7 Action

This parameter shows the action that will be performed when this device indicates an active (alarm) condition. For example:

[Loop 1 Devices]		<More>
Address	Action	Sensitivity O/P
001.0	FIRE SIGNAL	DEFAULT
002.0	FIRE SIGNAL	DEFAULT
003.0	FIRE SIGNAL	DEFAULT
004.0	FIRE SIGNAL	DEFAULT

Press the ✓ button to change the action assigned to this input device. A pop-up window is then shown on the display from which an action can be selected.

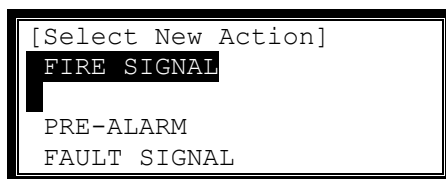

Press the ↑↓ buttons to scroll through the list of Actions and then press the ✓ button to confirm the change. The display reverts to the device list showing the new action assigned to this device. Alternatively, press the 'Esc' button to cancel the changes and return to the device list display. The following Actions are available.

Action	Description
Fire Signal <sup>8</sup>	A Fire Alarm Condition will be generated whenever the input is active.
Pre-Alarm	A Pre-Alarm Condition will be generated whenever the input is active.
Supervisory	A Supervisory Condition will be generated whenever the input is active
Create Alarm 1	An "Alarm 1" condition will be generated whenever this input is active.
Control Signal	Allows control of Outputs without displaying "Fault" or "Fire" or sounding buzzer
Fault Signal	A Fault Condition will be generated whenever the input is active.
Key Lock	Enables / Inhibits front panel controls (Disable, Mute, Reset etc.)
Acknowledge	Activation of the input acknowledges a Stage 1 Investigation Delay and invokes the Stage 2 Timer
Security	A Security Alert Condition will be generated whenever the input is active.
-	No Action is assigned to the input.
LED Test <sup>9</sup>	Activation invokes a test of the panel LED Indicators.



Additional actions are available via the PC Tool.

### 3.3.2.8 Sensitivity

Refer to the appropriate protocol application note for further information.

This parameter shows if the device sensitivity is set to its "DEFAULT" or "CUSTOM" settings. For example:

```
[Loop 1 Devices] <More>
Address Sensitivity
001.0 DEFAULT
002.0 DEFAULT
003.0 CUSTOM
004.0 DEFAULT
```

Press the  button to change the sensitivity assigned to an input device. When selected a new screen displays the sensitivity settings assigned. For example, with an Apollo Discovery device:

```
SENSITIVITY ADJUST MODE (ION SMOKE )
[ Alarm = 55 ]
[ Mode = 3 ] [ Pre-Alarm= 45 ]
[ Delay = 5s ] [ Min.Value= 8 ]
[SAM/SSM]
```

Press the     buttons to highlight the required menu option and then press the  button to select it. Use the **number** buttons to enter the required value. Alternatively, press the 'Esc' button to cancel the changes.

The alarm thresholds and delay times can be unique for every device if required.



*Always ensure that the values chosen are suitable for the particular installation and that reliable fire coverage is maintained at all times.*

<sup>8</sup> Fire Alarm Conditions are latched. By default, all other conditions are non-latching. The action for smoke and certain other detectors is always fire and cannot be changed.

<sup>9</sup> LED Test can only be configured using the PC Tool.

## Mode

This option is shown on the display for specific device types only. Refer to the appropriate protocol application note for further information.

## Delay

The value in this field defines the delay from detecting an alarm to entering the alarm condition. The delay time can be changed in 1-second increments.

## Alarm Level

The Alarm Level is the level of the analogue value returned by the detector at which the panel will enter a Fire Alarm Condition. Refer to the appropriate protocol application note for further information.

## Pre-Alarm

The Pre-Alarm Level is the level of the analogue value returned by the detector at which the panel will enter a pre-alarm condition.

## Minimum Value

If the detector analogue output falls below the minimum value programmed, the panel will enter a fault warning condition. Refer to the appropriate protocol application note for further information.

## Special Sensitivity Mode SSM/Clock

In addition to the "SENSITIVITY ADJUST MODE", a device can also run in a "SPECIAL SENSITIVITY MODE" (SSM) under time-clock control.

All panels supports 10 independent, 7-day time clocks.

With the SAM/SSM Option highlighted, press the  button to view the Special Sensitivity Mode settings. For example:

```
SPECIAL SENSITIVITY MODE (MULTI.SENSOR)

[SSM/Clock =    2 ][ Alarm =    55 ]
[ Mode =    5 ][ Pre-Alarm=    40 ]
[ Delay =    5s][ Min.Value=    8 ]
[SAM/SSM]
```

In the above example the panel is using special sensitivity mode 5 (and time clock number 2). Enter "0" in the SSM/Clock field to cancel Special Sensitivity Mode.

A number must be entered in the SSM/Clock field to select the appropriate SSM number and time clock. To view the time clock settings, highlight the SSM/Clock field, and press the  button.

For example:

```
[Time Clock 2]
DAY      ON  -> OFF      ON  -> OFF
MON      00:00 00:00    19:00 00:00
TUE      00:00 06:30    00:00 00:00
WED      00:00 00:00    00:00 00:00
THU      00:00 00:00    00:00 00:00
```

The panel supports two independent times for each day of the week during which the SSM mode will be switched on (i.e. during which the Special Sensitivity Mode settings are active)

In the above example the SSM will be active between 19:00 on Monday and 06:30 on Tuesday.

Press the     buttons to select the appropriate time field and use the **number** buttons to enter the required times. Press the 'Esc' button to return to the previous menu display.

Every type of device (the device type is shown in the top, right hand corner) supports unique SSM settings for each SSM/Clock number. In the previous example the Special Sensitivity Mode settings have been defined for a Multi-Sensor that is using SSM/Clock number 2. If other Multi-sensors on the same panel also require the same

settings, then you only need to set them to SSM/Clock 2. If instead another Multi-Sensor requires a different setting, use a different SSM/Clock number.

### 3.3.2.9 O/P Group

The Output Group assigned to the Sounder or Relay Devices determines the manner in which the outputs will operate when a fire alarm or other programmed condition occurs.

For example:

[Loop 1 Devices]		<More>
Address	O/P Group	
020.0	199	
021.0	199	
022.0	199	
023.0	199	

Use the **number** buttons to change the value of the O/P Group setting.

By default, all Loop Output devices are assigned to Output Group 199.

For detailed information and guidance on the programming and use of Output Groups, refer to Section 5.4

### 3.3.2.10 Additional Info

This parameter shows additional information, if available, for this device. For example, the following display shows the Apollo detector series types:

[Loop 1 Devices]		<More>
Address	Additional Info	
001.0	Disco	
002.0	XP95	
003.0	Disco	
004.0	Disco	

Refer to the appropriate protocol application note for further information.

### 3.3.2.11 Device Testing

Individual detectors can be tested to check the chamber response and illuminate the detector LED and individual outputs (sounders and relays) can be tested to check output connections and operation.

While the address field is highlighted, press the **↑↓** buttons to scroll through the list of devices to the desired device (or key in the address, and then press the **✓** button).

[Loop 1 Devices]		<More>
Address	State	Type Value
005.1	Normal	SOUNDER -
006.0	Normal	MULTI.SENSOR 16
006.1	Normal	RELAY -
007.0	Normal	CALL POINT 16

A menu will appear to confirm that you want to “Test This Device”.

Press the **✓** button to confirm or press the **‘Esc’** button to cancel.

Once selected, commands are sent to the detector to turn on the detector LED and put the chamber into test or are sent to the output device to turn the output on. The “Test” LED lights up and the panel display returns to the list of devices.

A few seconds after a detector is placed into test, the analogue signal will be seen to rise. If the detector is then left in the test condition, the Detector State will change to a “Fire Test” status.

The test is cancelled as soon as the display is scrolled up or down or when the ‘View Devices’ option is exited.

### 3.3.3 Loops – Auto Learn

#### 3.3.3.1 Normal Procedure / Initial learn

The panel can automatically learn the presence or absence of devices at all addresses connected to the loop. When the Auto Learn option is selected, the panel starts searching each address on the loop to locate and find all of the devices connected. A display is shown to indicate the progress of this procedure.

For example:

```
[Auto Learn Loop 1] HOCHIKI
Address 15 Devices found = 3
```

When all addresses have been searched, the panel displays a summary screen showing the quantity of devices found for each type of device.

For example:

```
[Auto Learn Loop 1] HOCHIKI
Address 127 Devices found = 4
OPT ION MUL TMP MCP SCC I/O ZMU OTHERS
0 1 1 1 1 0 0 0 0
```

This summary provides a quick check to ensure that the panel has found all of the devices that should be connected to the loop.

Press the 'Esc' button to return to the main Loops Menu.

#### 3.3.3.2 Procedure if the Panel finds Devices Missing

When the panel cannot communicate with a device previously programmed into the panel, the Auto Learn process is suspended and the display shows a pop-up window with options. For example:

```
KEEP THIS DEVICE
DELETE THIS DEVICE
KEEP ALL MISSING
DELETE ALL MISSING
! Address 002 DEVICE MISSING
```

If the missing device is kept (or all missing devices are kept), the panel remembers the programming for these devices. The panel will report a fault condition until such time as the missing devices are reconnected.

If the missing device is deleted (or all missing devices are deleted), the panel clears all previous programming for these devices. This includes any sensitivity threshold changes, text assignments, zone assignment, action, etc.

Press the  $\uparrow\downarrow$  buttons to highlight the required menu option and then press the  $\checkmark$  button to confirm. The pop-up window will disappear and the panel will continue with the auto learn process.

If a single device is deleted and another missing device is subsequently registered, the display will once again show the pop-up window to keep or delete this device.

### 3.3.3.3 Procedure if the Panel finds Devices Added

When the panel finds a device not previously learnt and programmed in the panel, the Auto Learn process is suspended and the display shows a pop-up window with options. For example:

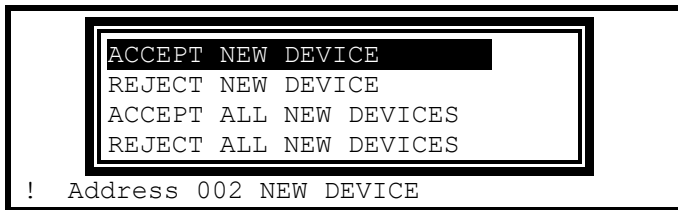

If the new device is accepted (or all new devices are accepted), the panel will configure the memory to register these devices. All data will be configured to initial settings for sensitivity threshold changes, text assignments, zone assignment, action, etc. for these devices.

If the new device is rejected (or all new devices are rejected), the panel clears all programming for these devices and will not attempt to communicate with the devices at these addresses.

Press the  $\uparrow\downarrow$  buttons to highlight the required menu option and then press the  $\checkmark$  button to confirm. The pop-up window will disappear and the panel will continue with the auto learn process.

If a single device is accepted / rejected and another new device is subsequently registered, the display will once again show the pop-up window to accept or reject this device.

### 3.3.3.4 Procedure if the Panel finds Devices Changed

When the panel finds a new type of device installed at an address previously learnt and programmed in the panel, the Auto Learn process is suspended and the display shows a pop-up window with options. For example:

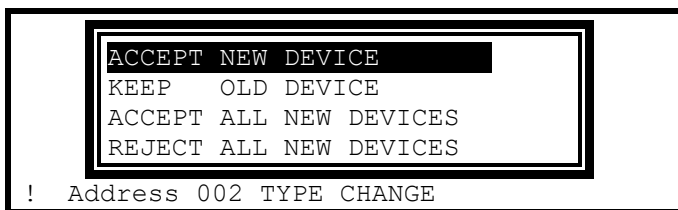

This situation could arise for example if a heat detector has been installed in place of an optical smoke detector.

If the new device type is accepted (or all new device types are accepted), the panel will configure the memory to register these devices. All data will be configured to initial settings for sensitivity threshold changes, text assignments, zone assignment, action, etc. for these devices.

If the new device type is rejected (or all new device types are rejected), the panel remembers the programming for the original devices. The panel will report a fault condition until such time as the correct device types are reconnected.

Press the  $\uparrow\downarrow$  buttons to highlight the required menu option and then press the  $\checkmark$  button to confirm. The pop-up window will disappear and the panel will continue with the auto learn process.

If a single device is accepted / rejected and another new device type is subsequently registered, the display will once again show the pop-up window to accept or reject this device.

## 3.3.4 Loop – Calibrate

Calibrates devices – Note this can take up to several minutes if many detectors & sounder bases are installed.

## 3.3.5 Loop - History

Displays basic event history for each device and sub-address.

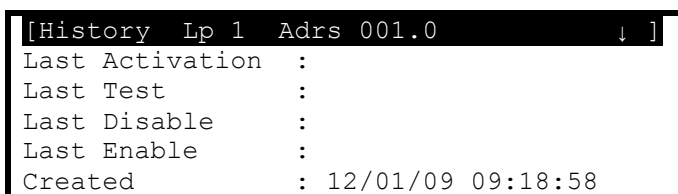

Item	Description
Last Activation	The date and time that the device was last activated (e.g. smoke level detected is at pre-alarm or alarm levels or the last time that an output was turned on).
Last Test	The date and time that the device was last tested (e.g. smoke level detected is at pre-alarm or alarm levels or the last time that an output was turned on).
Last Disable	The date and time that the device was last disabled.
Last Enable	The date and time that the device was last re-enabled.
Created	The date and time that the device was either auto-learnt at the panel or added to the device list from a PC configuration.

### 3.3.6 Loop – Meter

Displays loop output and input voltages and loop loading.

A diagnostic display with automatic scanning of the loop to find devices with minimum and maximum communication pulse heights is available.

### 3.3.7 Loop – Scope

This function displays the loop input and output voltage and current measurements in the form of a waveform. Refer to separate application note (HS680-505) for details of this feature.

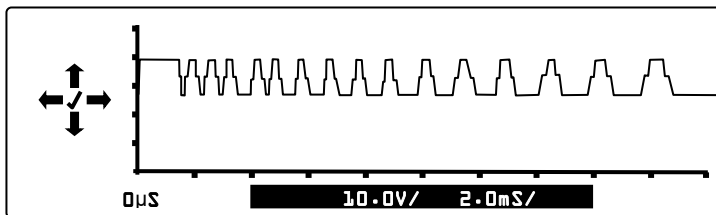

### 3.3.8 Zones

The Commission Zones option lists all the zones in use by this panel and allows the zone text description to be changed.

```
[Commission Zones]
Zone  Location
0001  BASEMENT WEST
0002  RECEPTION
0015  EAST WING
0018  TOWER BLOCK
```

To change the location text assigned to the Zone, press the ✓ button when the Zone Location Text is highlighted. Refer to Section 3.1.4 for guidance on how to change text descriptions.

To select a different zone, use either the scroll up/down keys, or just type in the number of the required zone, followed by the ✓ button. Note that only zones in use are displayed.

### 3.3.9 Exit

To exit the Commission Mode and return the panel to normal operation (i.e. level 2), select the “Exit” option. The display will prompt for confirmation of the Level 3 password. For example:

```
[Commission Menu 1]
Please Enter Your Password
Next Menu
```

If the password is incorrect (this will be indicated) or if the password is not entered within 5-seconds, the display will revert to the Commission Level Menu and level-2 will not be entered.

After commissioning, the panel must always be returned to level 2 (or level 1) to give normal fire coverage.



### 3.3.10 Disable

This function is the same as User Level 2 function – refer to User Manual for further information.

The following options can be disabled:

- ◆ Zones / Inputs
- ◆ Outputs
- ◆ Groups



*If beacon outputs are configured so that they can be independently disabled / enabled, then configure one of the front panel “Function” LED indicators to indicate the disabled state of these devices.*

### 3.3.11 Enable

This function is the same as User Level 2 function – refer to User Manual for further information.

The following options can be disabled:

- ◆ Zones / Inputs
- ◆ Outputs
- ◆ Groups

### 3.3.12 View Options

The View Menu Options are identical to those available during Level-2 operation – refer to User Manual for further information.

### 3.3.13 Passwords

The panel provides up to 10 User Level-2 passwords and 2 Level-3 passwords. All of the passwords <sup>10</sup> can be changed.

On entry to the function, the display shows a list of the passwords. For example:

Password	Access level	User ID
15633	2	01
9988	2	02
13344	2	03
10000	2	04
10000	2	05

To change a password, use the **↑↓** buttons to highlight the required password and then enter the new password using the **number** buttons. When the password is correct, press the **✓** button to confirm.

*Level-3 Passwords.*



*Care should be taken when changing the Level-3 password. If this new number is lost, it is not possible to enter commission mode functions.*

*Refer to 5.1 for further information.*

The factory default level 3 password is **7654**

<sup>10</sup> The passwords can be further qualified using the PC CONFIG TOOL to provide permission / restriction to specific menu options. See User Manual UI-ELAN-02 and PC CONFIG TOOL Manual for further details.

### 3.3.14 Time and Date

This function allows the time and date in the panel to be changed. On entry to the function, the display shows the current time and date with confirmation of the day of the week on the bottom line. For example:

```
[SET TIME/DATE]

TIME = 15:28
DATE = 15/01/09   THU 15 JAN 2009
```

To change the settings, use the  $\uparrow\downarrow$  buttons to highlight the required option. Directly enter the new time or date using the **number** buttons. As soon as a **number** button is pressed, the display will clear the current setting and show the new value as it is entered. For example:

```
[SET TIME/DATE]

TIME = 1█:--
DATE = 15/01/09   THU 15 JAN 2009
```

### 3.3.15 PC Config

The PC Link Option enables the connection of the PC Configuration Tool for retrieving configuration data from the panel and programming configuration data from a file on the PC.

For further information, refer to the Manual supplied with the PC Configuration Tool.

### 3.3.16 EN54-13

The EN54-13 menu defines whether EN54-13 transmission path monitoring is in use and defines the actual load current (shown in milliamps) to be used in the calculation for each of the base card loop and sounder circuits.

If enabled, the panel monitors the circuits to ensure that at the specified load current, the circuit can deliver the load current whilst still maintaining circuit device voltage compatibility levels via the transmission path resistance.

```
[EN54-13 Setup]

In Use           : 
Loop Circuit 1   : 500 mA (Max) 2%
Loop Circuit 2   : 500 mA (Max)
Loop Circuit 3   : 500 mA (Max)
```

Use the  $\uparrow\downarrow$  buttons to scroll through the list of options.

Press the  $\checkmark$  button to select between “in use” and “not in use” <sup>11</sup>.

Use the **number** keys to enter / change the load current for each circuit. The default values are the circuit maximum.

Circuit	I minimum	I maximum	EOL Voltage
Loop Circuit	25mA	500mA	17V
Sounder Circuit	100mA	1000mA	15V

The actual load for each circuit in alarm can be viewed using the View Panel option (see 3.3.12 and user manual).

<sup>11</sup> When “Not In Use” is selected, the panel will still continue to monitor the circuits for open circuit and short circuit conditions. Loop circuits are monitored via the return voltage on the loop. Sounder circuits must be terminated using the standard EOL resistors.

### 3.3.17 Setup

The Setup Options Menu enables the configuration of panel generic operating parameters. When the option is selected, the display shows a list of the available parameters. For example:

```
[Setup]
THIS NETWORK NODE : 0
NEXT NETWORK NODE : 0
PANEL ZONE       : 100
SERVICE NUMBER  : 01234 567890
```

Use the **↑↓** buttons to scroll through the list of options. The following will then be shown:

```
[Setup]
SERVICE DUE DATE : 1 JAN 2011 10:00
TRACE LOGGING MODE : STANDARD More>
DETECTOR BLINKING : NONE
COMPANY LCD LOGO  : ✓
```

#### 3.3.17.1 Network

This Network node is set to 0 for a standard non-networked panel. For panels in a networked application please refer to the Network document, reference: HS680-502.

#### 3.3.17.2 Panel Zone

By default all the panel inputs are assigned to the Panel Zone. Alternatively the PC configuration program allows individual inputs to have different zones if required.

#### 3.3.17.3 Service Number

The Service Number is the telephone number that is shown on the status display whenever a fault condition is accepted. To change the number, press the **✓** button when the option is highlighted. The number is entered using the text entry facility; refer to Section 3.1.4 for guidance on how to enter text.

#### 3.3.17.4 Service Due Date

The next service (over) due date can be entered into the panel memory. When this date is reached, the panel will enter a fault condition to alert the site operator that a service visit is overdue. To change the due date, press the **✓** button when the option is highlighted. The display prompts for entry of the next service date. For example:

```
[NEXT SERVICE DUE]
TIME = 12:00
DATE = 24/04/12
```

Use the **↑↓** buttons to select between the time and date. Use the number buttons to enter the required time or date.

As soon as a new service date is entered, the panel will cancel any Service Due Fault condition.

#### 3.3.17.5 Trace Logging Mode

The Trace Logging Option determines what type of information and to what level is stored in the Event Log.

There are three options:

**STANDARD** = the normal operating mode logging fire alarm, fault and warning conditions as they occur.

**STANDARD +** = an extended version of the standard operating mode where the removal of fault and warning conditions are also logged.

**DIAGNOSTIC** = a full diagnostic trace of all conditions with greater depth to aid diagnosis of fault conditions.

To change the option, press the **✓** button.

To erase the event log, press the → button to view the additional command option as follows:

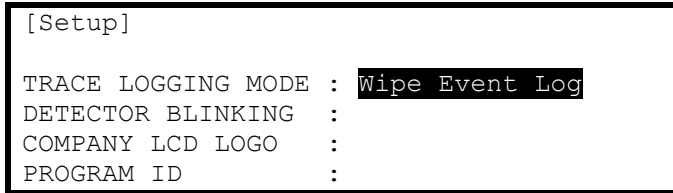

Press the ✓ button and the display will show that the event log is being erased by display the message “WORKING...” After the event log is erased, the display reverts to the Set-up Options screen.

### 3.3.17.6 Detector Blinking

The Detector Blinking option determines whether the LED indicators on the devices will blink whenever the panel polls the device. To change the operation, press the ✓ button. The display presents a list of options. For example:

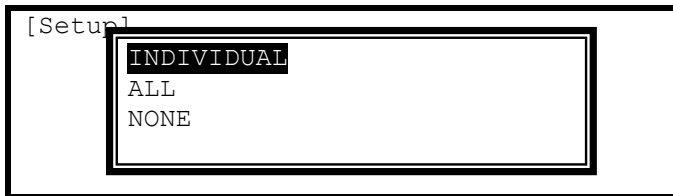

Use the ↑↓ buttons to scroll through the list of options and press the ✓ button to confirm the selection.

The device LED indicators will not blink if NONE is chosen or will blink if ALL is chosen. Note that only certain devices, such as Apollo Discovery, support this feature.

If a device, such as a Discovery device, is changed it may be necessary to select and reconfirm the blinking command so that the new device will blink its LED.

The INDIVIDUAL option should be chosen when it is required that only certain devices should blink their LED. The devices that shall blink their LED can only be programmed using the PC Configuration Tool.

### 3.3.17.7 Earth Fault Notification

This parameter determines whether an Earth Fault is shown on the display during normal operation. To change the setting, press the ✓ button. The status changes from ✓ to X and vice versa.

### 3.3.17.8 Resound

The Resound option defines whether silenced sounders shall resound when either a new zone is in alarm (default EN54-2 setting) or a new device is in alarm.

### 3.3.17.9 Config Data

The Config Data option shows the loop protocol selected and the checksum for the configuration data. A note of this number can be taken and then checked on the next service visit to see if any changes have been made to the configuration data.

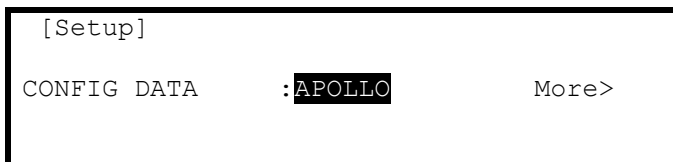

To change the protocol, press the ✓ button. A pop up window is shown with the following options



Use the  $\downarrow\uparrow$  buttons to select the required options and press the  $\checkmark$  button to confirm the selection.

Selecting "CHANGE LOOP PROTOCOL" will toggle to the alternative loop protocol available (e.g. Apollo/Hochiki). For Mx-5000N Series panels the protocol is fixed as NITTAN.



*Changing between protocols will automatically erase all loop devices from the configuration memory. Perform an "Auto-Learn" or use the PC Config Tool to re-define the devices connected to the loop.*

To view the Config Data Checksum, press the  $\rightarrow$  button. The display then shows:

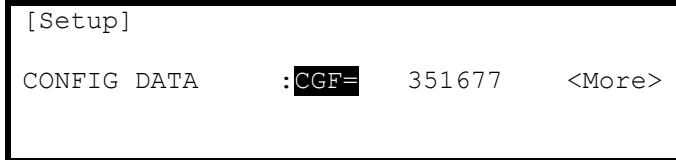

In addition, there is an option to erase the Config Data. Press the  $\rightarrow$  button. The display then shows:



Press the  $\checkmark$  button. A pop-up menu will be shown to confirm whether the configuration data shall be erased.

### 3.3.18 Display

Depending on the physical mounted height of the panel, the contrast of the LCD may need adjusting to obtain optimum viewing. The display option permits the contrast adjustment of the LCD.

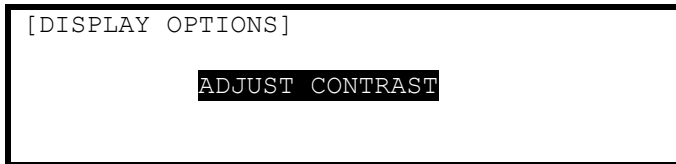

Press the  $\checkmark$  button. The following display is shown:

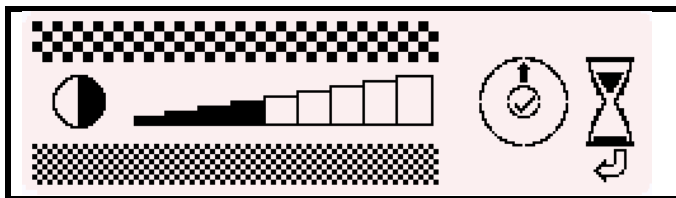

Use the  $\uparrow\downarrow$  buttons to adjust the contrast viewing angle for darker or lighter as required (the setting is confirmed by the bar graph) and the press the  $\checkmark$  button to confirm the change. Press ESC to cancel. The display will automatically cancel if no button is pressed for 30 seconds (hour glass).

### 3.3.19 Panel

The Panel Menu Option shows a list of the internal panel circuits and provides a means to change their default configuration settings.

Only use this menu if changes are to be made to the default settings for the panel's internal circuits. Use the VIEW-PANEL Menu Option to view the state and operating condition of each circuit.

The display shows for example:

Address	State	Type	Value	More>
>001.0	Normal	VOLTAGE	5.6V	
001.1	Normal	VOLTAGE	5.6V	
002.0	Normal	CURRENT	0mA	
002.1	Normal	CURRENT	0mA	

Use the  $\uparrow\downarrow$  buttons to scroll through the circuits. Use the  $\leftarrow\rightarrow$  buttons to view additional information. The zone and Output Group Assignments can be modified if required.

For further information on the View – Panel Options and the information that is presented, refer to the User Manual.

#### 3.3.19.1 AC Fail Delay

The panel can be configured to delay the reporting of a loss of AC Mains supply (Address 14.0).

The front panel Green Power LED will still immediately flash on the loss of the AC Supply, but the fault condition is only reported after the delay time (default 10s) has elapsed.

SENSITIVITY ADJUST MODE (MONITOR )				
	[ Alarm =	*** ]		
	[ Pre-Alarm=	*** ]		
[ Delay =	10s]	[ Min.Value=	372 ]	
	[SAM/SSM]			

To delay the reporting of an AC Supply Loss, change the “Delay” setting<sup>12</sup>.

### 3.3.20 Output Groups

The “Cause and Effect” programming is a schedule of actions that will turn on one or more outputs dependant on a set of input events.

The Outputs Option provides the means to create simple or complex “cause and effect” programming within the panel. Delays can be introduced to allow a phased evacuation of a building (Note this is different to an “Investigation Delay” which is detailed in section 3.3.21).

This section describes the settings and options in detail for each parameter. Refer to [Appendix 4 – Cause and Effect Programming Example](#) for a description of how to program a typical requirement.

More complex “Cause and Effect” programming may be undertaken using the PC Configuration tool.

When the OUTPUTS Option is selected, the display shows the cause and effect programming for Output Group 1. For example:

[Output Group 1] [ 3.9% Mem used]					
ZONE	CAUSE	STYLE=Delay->MODE	Wait		
1	ANY FIRE	00 -	On		
2	ANY FIRE	00 -	On		
3	ANY FIRE	00 -	On		
4	ANY FIRE	00 -	On		

<sup>12</sup> For compliance with EN54-4, the loss of the AC Mains supply should not be delayed more than 30 minutes (1800s).

To simplify the cause & effect programming, one or more outputs that will respond in the same way when the same set of input events occurs can be grouped together. This association of outputs is called an Output Group. The panel can support up to 200 of these Output Groups.

To select a different Output Group, press the **↑** button to highlight the Output Group Number field and then enter the number of the output group required using the **number** buttons. The display always shows the Output Group is shown in the top left corner.

Press the **↑↓** buttons to scroll through the list of zones.

Press the **←→** buttons to select the fields for a specific zone.

Press the **✓** button to select a specific field option to change its setting.

### 3.3.20.1 Default Output Settings

On initial installation, or after clearing the configuration memory, all outputs are assigned to specific Output Groups and will turn on immediately a single fire alarm occurs in any zone (any fault condition for the fault relay). The default assignments are as follows:

Output Device	Output Group	Cause and Effect
On-board Sounder A	1	Any fire in any zone – no delay
On-board Sounder B	1	Any fire in any zone – no delay
On-board Sounder C <sup>13</sup>	1	Any fire in any zone – no delay
On-board Sounder D <sup>13</sup>	1	Any fire in any zone – no delay
On-board Relay 1 <sup>14</sup>	200	Any fault in any zone – no delay
On-board Relay 2 <sup>14</sup>	199	Any fire in any zone – no delay
On-board Open Collectors <sup>14</sup>	199	Any fire in any zone – no delay
Fault Routing Output <sup>15</sup>	200	Any fault in any zone – no delay
Fire Routing Output-A <sup>15</sup>	199	Any fire in any zone – no delay
Fire Routing Output-B <sup>15</sup>	199	Any fire in any zone – no delay
All Loop Output Devices	199	Any fire in any zone – no delay

### 3.3.20.2 Cause

Each Output Group can be programmed to respond in a unique way to events from each individual zone. An input event may be a fire alarm condition, or it may be a fault, disablement or other condition. A combination of criteria may also be applied to each zone.

The Cause field determines what type of input event (or a combination of input events) will generate an output response for the selected input zone.

[Output Group 1]		[ 3.9% Mem used]		
ZONE	CAUSE	STYLE=Delay->MODE	Wait	
1	ANY FIRE	00 -	On	
2	ANY FIRE+	00 -	On	
3	ANY FIRE	00 -	On	
4	ANY FIRE	00 -	On	

<sup>13</sup> HS-5400 Only

<sup>14</sup> This Output is used for routing if the non-monitored routing option is selected.

<sup>15</sup> This Output is available on the optional Routing Interface Peripheral Card.

Press the ✓ button to change the setting and a pop-up window will appear showing the options available. For example:

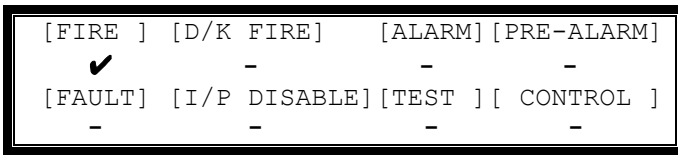

Press the ←↑↓→ buttons to highlight the required menu option and then press the ✓ to change its setting. An input action type is enabled when a '✓' is shown beneath the option. It is permitted to select multiple input types in which case a combination of input events will result in an output action. If there is a combination of input events, the CAUSE display above shows this extended programming by adding a '+' to the text. For example, Zone 2 above shows that the basic event is ANY FIRE + other criteria.

Press the 'Esc' button to return to the previous display.

The definition for each cause is as follows:

Cause	Definition
Fire	Any single fire.
Double Knock (D/K)	Coincidence of 2 or more fire detectors or a single manual call point in the same zone.
Alarm	Activation of an input device programmed with an 'Alarm' action.
Pre-Alarm	A device in a pre-alarm condition.
Fault	Any device entering a fault condition.
Input Disabled	Whenever an input device is disabled.
Test	A 'Walk Test' fire in the zone.
Control	A control input in this zone will cause activation.

**Section 7.12**

**Type C: Coincidence Detection.**  
**The operation of the Coincidence Detection (Double Knock) feature is on a per zone basis.**

**PC**  
ONLY

**Type B: Confirmation.**  
**Optional confirmation filters can be configured via the PC Tool on individual devices.**

### 3.3.20.3 Style

The way in which an output turns on in response to a particular input event can be programmed. For example, an output may turn on immediately, it may turn on after a delay or it may pulse for a set time and then turn on. This method of operation is called a Style. A style may have up to three different methods of operation. For example,

Delay→ Mode, Wait→ Mode, Wait→ Mode.

- Style 00 is fixed to turn on immediately an input event occurs.
- Style 01 is fixed to pulse immediately an input event occurs.
- Styles 02 to 20 are programmable.

Press the → button to step on to the style field. Change the setting using number entry to select the required output style. If the style is already programmed elsewhere, the relevant style parameters are automatically entered into the appropriate fields.

### 3.3.20.4 Delay

The delay field is the time from qualification of the input event to something happening at the output. The delay time can be set in intervals of 1 second up to a maximum of 250 seconds.

Press the → button to step on to the delay field and change the setting using number entry.



### 3.3.20.5 Mode

The mode field defines the method of operation of the output when it is first activated. This can be ON or PULSE.

Press the → button to step on to the delay field and change the setting using the ✓ button.

Note: Pulse settings are by default 1-second ON / 1-second OFF. Other pulse options can be specified on the PC Tool (such as 2s ON / 3s OFF) – these can be assigned to on-board outputs only.

### 3.3.20.6 Wait

The wait field is the time from first activation of the output to the next operational condition (mode) of the output. For example, the output could initially be delayed for 20 seconds and turn on in a pulsing mode. After a wait of a further 30 seconds it can be programmed to turn on differently such as ON. The wait time can be set in intervals of 1 second up to a maximum of 250 seconds.

Press the → button to step on to the wait field and change the setting using number entry.

### 3.3.20.7 Copying Output Settings to Multiple Zones

To save time in the entry of similar Output Group Settings for each zone, it is possible to copy information programmed for a particular zone to subsequent zones.

Press the ← button to highlight the required zone number and then press the ✓ button. The display shows a pop-up window prompting for the number of the zone to which to copy the information.

Use the number entry to select the required zone number. The Output Group programming for all of the zones from the currently selected zone to the zone number entered will be programmed with the same information as the currently selected zone.

## 3.3.21 Investigation Delays



*In addition to the “Cause and Effect” programming described above, the panels also support an “Investigation Delay Mode” which allows time for a building supervisor to investigate fire signals before turning outputs on. This mode can only be configured from the PC software.*

There are two parts to this delay. The first stage is set relatively short. If the building supervisor does not acknowledge the fire signal within the first stage, the delayed outputs will turn on. The second stage gives a longer period to investigate the fire signal. This delay can be cancelled at any time by pressing the EVACUATE button, or any nominated input devices (by default, all call points cancel this mode).

Each input and output device can be individually programmed to use the investigation delay from the PC configuration software, together with the times appropriate to each stage of the delay. The user manual gives details of how the building occupier can turn the investigation delay feature on or off.



### Section 7.11

#### Delays to Outputs.

**It must be possible to override the operation of any delays at Level 1. Refer to Section 3.3.21.1 for information on overriding delays.**

**For compliance, the maximum total delay permitted is 10 minutes.**

### 3.3.21.1 Overriding Delays at Level 1

A facility to override any programmed delays and immediately activate the sounder circuits should be provided at Level 1. It is possible to override the delay using the panel controls (see the user manual for details). This can also be achieved from an input device (such as a manual call point) that is programmed to turn on all outputs immediately.

### 3.3.22 Test

This function is the same as User Level 2 function – refer to User Manual for further information.

The following functions can be tested:

- ◆ Zones / Inputs
- ◆ Display
- ◆ Buzzer
- ◆ Printer
- ◆ Outputs

### 3.3.23 LED Indications

This option is not provided from Software Version 050-04.

The operation of all HSP-513-XXX LED Indicator Cards MUST be configured using the PC Tool.

Panels equipped with integral panel LED indicators on the display card will default to indicate fire alarms in Zones 1-20. The operation of these can be adjusted using the PC Tool.



Each LED can be individually configured via the PC Tool to either zone assignment, output group assignment or other function.

## 4 Service and Maintenance

### 4.1 Maintenance Schedule

This equipment should be maintained in accordance with the regulations and codes appropriate to the country and location of installation. The following is recommended if no other regulations apply.

#### 4.1.1 Daily Actions

The site operator / user should perform the following checks and actions:

- a) The panel indicates normal operation. If any faults exist, these should be recorded in a logbook.
- b) Any recorded faults have received attention and have been signed off.

#### 4.1.2 Monthly Actions

The site operator / user should perform the following checks and actions:

- a) Any stand-by generators should be started, and fuel levels checked.
- b) Operate at least one call point or detector (from different zones each month) and check that the panel enters a fire alarm condition and that the appropriate / programmed alarm or warning devices are sounded / operated. Where permissible, this should include any links to the fire brigade or remote centre.
- c) Check that all outstanding faults have been recorded and have received attention.

#### 4.1.3 Quarterly Actions

The service / maintenance contractor should perform the following checks and actions:

- a) Check that all entries in the logbook have been addressed, check the event log in the panel and take the necessary remedial actions.
- b) Visually inspect the panel for any moisture ingress or other deterioration, check all battery connections and test / check the alarm, fault and other functions of the panel operation.
- c) Ascertain if any building or structural alterations have been carried out that would affect the placement / location of call points or detectors. If so, perform a visual inspection.
- d) Record in the logbook any defects or remedial actions that must be undertaken and arrange for these to be carried out as soon as possible.

#### 4.1.4 Annual Actions

The service / maintenance contractor should perform the following checks and actions:

- a) Perform the checks as recommended above in the daily, monthly and quarterly schedules.
- b) Perform a complete "Walk Test" of the system to check that each call point and detector is operating to its manufacturers' specification.
- c) Visually inspect all cable fittings. Check that the equipment is undamaged and that the conditions of installation have not changed such that they fall outside of the equipment specifications.
- d) Inspect and test all batteries and replace as required – refer to Section 4.2 for recommended replacement schedule.
- e) Record in the logbook any defects or remedial actions that must be undertaken and arrange for these to be carried out as soon as possible.

## 4.2 Replacement of Components

In general, all of the components used in the construction of the panel have been selected for long life and reliability.

However, certain components may require to be changed on a regular service basis. The details of these are as follows:

### 4.2.1 Batteries

For battery installation and replacement, see section 2.5.2



**Risk of Explosion if the battery is replaced by an incorrect type.  
Refer to Section 4.2.1.1 for a list of recommended batteries**



**Respect the Environment.  
Batteries must be disposed of responsibly and in accordance with any local regulations.**

#### 4.2.1.1 Standby Batteries

The following table lists the Yuasa and Powersonic batteries which have been tested for use with HS-5000 Fire

Panel

Capacity (Ah)	Yuasa		Powersonic	
4	NP4-12FR			
4.5			PS-1242 FR	PS-1242 V0
7	NP7-12FR		PS-1270 FR	PS-1270 V0
12	NP12-12FR		PS-12120 FR	PS-12120 V0
17	NP17-12FR	NP17-12IFR		
18			PS-12170 FR	PS-12170 V0
24	NP24-12FR	NP24-12IFR	PS-12260 FR	PS-12260 V0
38	NP38-12FR	NP38-12IFR	PS-12380 FR	PS-12380 V0
45			PS-12450 FR	PS-12450 V0



**To comply with the low voltage directive product safety standard EN 62368-1, batteries fitted and replaced in the fire panels must meet the flammability requirements of UL:94-V2 or better.(V-1 or V-0) Powersonic and Yuasa batteries listed below meet these requirements.**

*For optimum performance and charge retention, Yuasa recommend that batteries are 'top-charged' prior to installation.*



*For batteries up to 6 months old from date of manufacture, charge at 2.4V per cell (i.e. 14.4V per battery) for 20 hours prior to installing the batteries.*

*It is not recommended to use batteries that are more than 6 months old, from their date of manufacture, on a new installation.*

- Expected Life: - 3-5 years at an ambient temperature of 20°C
- Replacement Schedule: - As above. However, note that the expected battery life is shortened by increase in ambient temperature. The life reduces by 50% for every 10°C rise above ambient. Refer to battery manufacturer for further information.

## 4.2.2 Liquid Crystal Display

- Expected Life: - > 10 years
- Replacement Schedule: - When the display becomes difficult to read. The display contrast will gradually fade with time.
- Manufacturer / Part Number: - Replace the complete display / keyboard assembly. Spare part number MXS 504.

## 5 Appendices

### 5.1 Appendix 1 – Forgotten Level 3 Password

Should the Level-3 password be forgotten, contact Customer Support to obtain a temporary permit number to regain access to the panel programming functions.

Customer Support will require a decryption key displayed by the panel. To obtain this number, attempt to gain access to the Level-3 Programming Functions entering “1” when prompted for the password. As soon as the “Password Invalid” message is shown, press the “0” button and the display will show a decryption key. Make a note of the first part of this number.

For example:

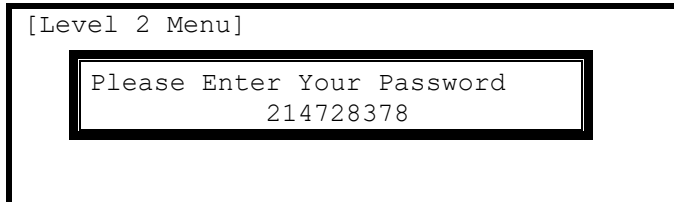

Customer Support will provide a temporary permit number that you can enter when prompted for the Level-3 password. As soon as access has been regained to the Level-3 Programming Functions, select the Passwords Menu Option and check / change the Level-3 password. (Refer to Section [3.3.13](#) for further information).

## 5.2 Appendix 2 – Recommended Fire Rated Cables

The following table provides a list of suitable fire rated cables with standard (30 minute) and enhanced (120 minute) classification. Refer to Document No. HS680-088 for an up to date list.

Manufacturer	Cable Type	Core Sizes (mm)			5839-1 Rated		Net
		1.0	1.5	2.5	S <sup>(30)</sup>	E <sup>(120)</sup>	
AEI	Firetec Multicore Ref. F1C	✓	✓	✓			✓
AEI	Firetec Armoured Ref. F1C	✓	✓	✓			✓
Calflex	Calfam CWZ (2.5mm <sup>2</sup> )			✓			
Cavicel SpA	Firecel SR/114H	✓	✓		✓		
Cavicel SpA	Firecel SR/114E	✓	✓	✓		✓	
Draka	Firetuf (OHLS) FTZ	✓	✓		✓		✓
Draka	Firetuf PLUS	✓	✓	✓		✓	
Huber & Suhner	Radox FRBS/M1x2		✓	✓			✓
Irish Driver-Harris Co Ltd	Kilflam 2000	✓	✓	✓	✓		
Irish Driver-Harris Co Ltd	Kilflam 3000	✓	✓	✓		✓	
Pirelli	FP200 Flex (1.0mm <sup>2</sup> )	✓					✓
Pirelli	FP200 Gold (1.0mm <sup>2</sup> )	✓	✓	✓	✓		✓
Pirelli	FP PLUS	✓	✓	✓		✓	
Tratos Cavi SpA	FIRE-safe TW950	✓	✓	✓	✓		
Tyco Thermal Controls	Mineral Insulated Twin Twisted PYRO-E CCM2T	✓	✓	✓			✓
Tyco Thermal Controls	Pyrotenax Served Mineral Insulated Cable (light and heavy duty)	✓	✓	✓		✓	
Tyco Thermal Control	Pyro-S	✓	✓	✓	✓		
Wrexham	Mineral Insulated Cable (light and heavy duty)	✓	✓	✓		✓	

### 5.2.1 Detector Loop Lengths – Apollo, Hochiki <sup>16</sup>

With the above cables, loops can be up to 2Km in length. However, care must be taken when designing the system to take into account the maximum loop loading. The voltage drop (load current x cable resistance) over the cable always needs to be taken into account to ensure the devices receive an adequate supply voltage. The following table gives recommendations for a loop. (It may be possible to extend the lengths where the devices are distributed evenly – refer to the device data sheets and Loop Calculators for further information on calculating loop loading, cable cross sectional area and loop distance).

Maximum Circuit Impedance	72Ω	Circuit Loading	Max. Circuit Impedance	Loop Cable Distance (M)		
Maximum Capacitance (Core-Core)	230nF			1.0mm <sup>2</sup>	1.5mm <sup>2</sup>	2.5mm <sup>2</sup>
Maximum Capacitance (Core-Screen)	410nF	100mA	55.0Ω	1500	2000	2000
Insulation Resistance (Core-Core and Core-Screen)	>2MΩ	200mA	27.5Ω	760	1130	1860
		300mA	18.3Ω	500	750	1200
		400mA	13.7Ω	380	560	920
		500mA	11.0Ω	300	450	740

NB: Maximum Circuit Impedance is the sum of the resistance of both cable conductors.

<sup>16</sup> See Nittan addendum for maximum line lengths with the Nittan protocol

### 5.2.2 Sounder Circuit Lengths

The voltage drop on each alarm circuit should be calculated to ensure that the minimum voltage at the end of the circuit exceeds the minimum required by each sounding device at the minimum alarm circuit output voltage.

The voltage at the end of the circuit is given by:

$$\text{Minimum Alarm Voltage} = V_{\text{OUT(MIN)}} - (I_{\text{ALARM}} \times R_{\text{CABLE}})$$

Minimum Output Voltage ( $V_{\text{OUT(MIN)}}$ ) is  $V_{\text{BAT(MIN)}} - 0.5V = 20.5V$

Alarm Current ( $I_{\text{ALARM}}$ ) is the sum of the loads presented by the sounding devices in alarm

Cable Resistance ( $R_{\text{CABLE}}$ ) is the sum of the cable resistance in both cores x cable length.

Cable Resistance ( $R_{\text{CABLE}}$ ) for 1.0mm<sup>2</sup> is 0.036Ω / metre

Cable Resistance ( $R_{\text{CABLE}}$ ) for 1.5mm<sup>2</sup> is 0.024Ω / metre

Cable Resistance ( $R_{\text{CABLE}}$ ) for 2.5mm<sup>2</sup> is 0.015Ω / metre

Insulation Resistance (Core-Core and Core-Screen)	≥2M Ω
--	-------

### 5.2.3 Fire / Fault Routing Circuit Lengths

The voltage drop on each transmission circuit should be calculated to ensure that the minimum voltage at the end of the circuit exceeds the minimum required by the relay coil at the minimum circuit output voltage. Typically, relays will energise at 75% of their nominal drive voltage (i.e. 18V for a 24V coil)

The voltage at the end of the circuit is given by:

$$\text{Minimum Coil Voltage} = V_{\text{OUT(MIN)}} - (I_{\text{ON}} \times R_{\text{CABLE}})$$

Minimum Output Voltage ( $V_{\text{OUT(MIN)}}$ ) is  $V_{\text{AUX(MIN)}} - 0.8V = 19.7V$

Maximum On Current ( $I_{\text{ON}}$ ) is 35mA.

Cable Resistance ( $R_{\text{CABLE}}$ ) is as above.

Insulation Resistance (Core-Core and Core-Screen)	≥2M Ω
--	-------

### 5.2.4 Network Cables

For a list of recommended cables, refer to the AdNeT document .



### 5.3 Appendix 3 – Battery Standby Calculation Chart

Use the following charts and associated notes to calculate the size of the batteries required to ensure operation of the installation in the event of AC Mains power failure. This chart is applicable to all panels except: 5100N, 5200N and 5400N<sup>17</sup>.

Equipment	Quiescent Load			Fire Alarm Load		
	I (A)	x	Total	I (A)	x	Total
<i>Chassis</i>	0.083	1.0	= 0.083	0.125	1.0	= 0.125
Loop Driver	0.042	1.0	=	0.042	1.0	=
Sensor / Loop Current <sup>18</sup>						
Loop Driver	0.042	1.0	=	0.042	1.0	=
Sensor / Loop Current						
Loop Driver	0.042	1.0	=	0.042	1.0	=
Sensor / Loop Current						
Loop Driver	0.042	1.0	=	0.042	1.0	=
Sensor / Loop Current						
Loop Driver	0.042	1.0	=	0.042	1.0	=
Sensor / Loop Current						
MXP-503 AdNeT Network Card	0.020	1.0	=	0.020	1.0	=
MXP-509 AdNeT PLUS Network Card	0.043	1.0	=	0.043	1.0	=
HSP-513 LED Indicator	0.008		=	0.030 <sup>22</sup>		=
MXP-507 2-Way Relay Card	0.000	1.0	0.000	0.030 <sup>22</sup>	1.0	=
MXP-532 Routing Interface	0.031	1.0	=	0.043 <sup>22</sup>	1.0	=
Auxiliary Supply Output <sup>23</sup>		1.0	=		1.0	=
Sounder Output A					1.0	=
Sounder Output B					1.0	=
Sounder Output C <sup>20 21</sup>					1.0	=
Sounder Output D <sup>20 21</sup>					1.0	=
<b>Total</b>	<b>ΣQuiescent Load</b>		<b>=</b>	<b>ΣAlarm Load</b>		<b>=</b>
		<b>x 24 hr =</b>	<b>Ahr</b>			
		<b>x 48 hr =</b>	<b>Ahr</b>			
		<b>x 72 hr =</b>	<b>Ahr</b>	<b>x 2<sup>24</sup> x 0.5 hr =</b>	<b>Ahr</b>	
			↵ (carry forward)	<b>+</b>	<b>Ahr</b>	
		<b>Total Load (Quiescent + Alarm) =</b>			<b>Ahr</b>	
		<b>x 1.25<sup>24</sup> (Battery De-rating factor) =</b>			<b>Ahr</b>	

<sup>17</sup> See Nittan protocol addendum for the battery calculation when using the Nittan protocol since the loop voltage is different to other protocols.

<sup>18</sup> Use the detector manufacturers' technical information to calculate the load on the loop for both the quiescent condition and fire alarm condition for all loop devices. By default, a maximum of 5 detector / call point LED indicators will be turned on in a fire alarm condition. (This number can be changed via the PC Programming Tool).

<sup>19</sup> The calculated loop loading must be multiplied by a factor of 1.25 to calculate the actual current draw from the batteries. This is to take into account voltage conversion and conversion efficiency in generating the supply for the loop.

<sup>20</sup> Not available on Mx-5100.

<sup>21</sup> Not available on Mx-5200.

<sup>22</sup> Worst Case – All LEDs are ON. All Relays / Outputs are ON.

<sup>23</sup> Refer to separate data sheets for the additional modules that can be powered from the panel AUX Output to determine the AUX loading currents. For example, the modules can include 4-Way Relay, 4-Way Sounder, Modem, Page, Sounder Splitter, etc. The sum of all these additional currents should be entered in these fields. Ensure that the total alarm load does not exceed the AUX output rating.

<sup>24</sup> The alarm load should be doubled to allow for changes in battery efficiency for loads in excess of the recommended C/20 discharge rate. The total load calculated should be multiplied by a de-rating factor of 1.25 to allow for changes in battery efficiency over time. The above calculation is in accordance with the recommendations in BS5839-1: 2013.

## 5.4 Appendix 4 – Cause and Effect Programming Example

### 5.4.1 Introduction

By default, all sounders and output devices will turn on immediately as soon as a fire is detected anywhere in the system. For example:

Cause	Effect
Any Fire, Anywhere.	→ ALL Output Devices will Turn ON

Quite often an installation will require a more complex “Cause and Effect” solution. Consider a multiple story building where phased evacuation is required when a fire occurs on a particular floor. For example:

Cause	Effect
Any Fire on Floor 7 (From Zones 22, 23 or 24)	→ Sounders on Floor 6 will DELAY for 30 seconds, then start PULSING. After 2 minutes turn ON
	→ Sounders on Floor 7 will Turn ON
	→ Sounders on Floor 8 will DELAY for 30 seconds, then start PULSING. After 2 minutes turn ON

### 5.4.2 Output Groups

There may be several sounders on each floor. These can be grouped together using the Output Groups so that a single group number can easily reference all sounders on a particular floor in the panel. For example:

Sounders	Output Group
Assign All Sounders of Floor 6	→ Output Group 6
Assign All Sounders of Floor 7	→ Output Group 7
Assign All Sounders of Floor 8	→ Output Group 8

Refer to Section 3.3.2.9 for how to assign the output group to a loop output device. Refer to Section 3.3.20.1 for how to assign the output group to an internal panel circuit.

### 5.4.3 Styles

In the example, there are two ways in which the sounders should ring. These two operational characteristics can be defined as Styles in the panel. For example:

The first Style is that the sounders should turn on immediately a fire is recognised in Zone 22 or in Zone 23 or in Zone 24. The panel contains a default Style (Style 00) for this method of operation.

The second Style is that the sounders should stay silent for 30 seconds and then start pulsing. After 2 minutes of pulsing, they should then turn on. This is a little more complex but is easy to program. In the following description, a new Style (Style 2) will be defined for this purpose.

It is quite likely that Style 2 will be used extensively in the cause and effect programming for the rest of the building. For example, a fire on Floor 8 may also require the sounders on Floors 7 and 8 to operate in this manner.

### 5.4.4 Output Group Programming

To achieve the above cause and effect requirements, the three different Output Groups would be programmed and indicated on the panel as in the following display examples:

Output Group 6 – Sounders on Floor 6:

[Output Group 6]		[ 3.9% Mem used]		[STYLE 02 ]		
ZONE	CAUSE	STYLE=Delay->	MODE	Wait	MODE	Wait
22	ANY FIRE	02	30s	Pulse	120s	On
23	ANY FIRE	02	30s	Pulse	120s	On
24	ANY FIRE	02	30s	Pulse	120s	On

More>

Output Group 7 – Sounders on Floor 7:

[Output Group 7]		[ 3.9% Mem used]		[STYLE 00 ]	
ZONE CAUSE	STYLE=Delay->MODE	Wait	MODE	Wait	MODE
22 ANY FIRE	00 -	On			
23 ANY FIRE	00 -	On			
24 ANY FIRE	00 -	On			

More>

Output Group 8 – Sounders on Floor 8:

[Output Group 8]		[ 3.9% Mem used]		[STYLE 02 ]	
ZONE CAUSE	STYLE=Delay->MODE	Wait	MODE	Wait	MODE
22 ANY FIRE	02 30s Pulse	120s	On		
23 ANY FIRE	02 30s Pulse	120s	On		
24 ANY FIRE	02 30s Pulse	120s	On		

More>

## 5.5 Appendix 5 – Other Useful Documents

The following reference and application documents may be useful in the design, configuration and installation of the system.

The latest versions of these and new / additional application notes are available from ([www.haes-tech.com](http://www.haes-tech.com)) or in hard copy format from Sales.

Title	Type	Description
Configuration Tool Software	Level 3 Tool	Explains how to configure the panel using the PC-NET Software.
Logo Software	Level 4 Tool	Explains how to create and update the logo in the panel using the PC-NET software.
Key Switch Access Control	Application Note	Explains how to configure the panel for use of a key switch for level 2 access.
Flash Programming	Level 4 Tool	Explains how to update the panel firmware with new software revisions.
External Printer Output	Application Note	Explains how to configure the panel and connect a serial RS232 printer.
Class Change Programming	Application Note	Provides examples of how to implement a class change function using different inputs.
Gated Time-Clock Programming	Application Note	Explains how to use an input to enable / disable a time-click function.
Hochiki Sounders and Outputs	Application Note	Explains how to configure the panel for operation with the ranges of sounders and output devices. Also details limitations.
Apollo Ancillary Base Sounders	Application Note	Explains how to configure the panel for operation with detector LED driven base sounders. Also details limitations.
Software Upgrades	Application Note	Explains how to upgrade the software in the Graphics Display Card and Fault Tolerant Network Card.
Cables for Fire Systems	Application Note	Gives further information on the cables than can be used.
Minimizing False Alarms	Application Note	Details the diverse methods that can be configured to assist in the reduction of false alarms.
Apollo Device Information	Application Note	Compatibility List and technical information
Hochiki Device Information	Application Note	Compatibility List and technical information
AV Device Information	Application Note	Compatibility List and technical information
Nittan Device Information	Application Note	Compatibility List and technical information
Mx-5000 Fire Routing / Protection	Application Note	Detailed information on how to configure and program fire routing and fire protection outputs
Mx-5000 <i>Ad-NeT</i> Network	Application Note	Explains how to install and configure the <i>Ad-NeT</i> <sup>™</sup> and <i>Ad-NeT-Plus</i> <sup>®</sup> networks.
Mx-5000 Bezels	Application Note	Details of how to fit semi-flushing bezels
Mx-5000 IFAM Configuration	Application Note	Detailed installation and configuration information for the IFAM FAT and FBF panels
Mx-5000 Scope Function	Application Note	Details of how to use the oscilloscope function
Mx-5000 Glass Door Kits	Application Note	Details of how to fit glass door kits
Mx-5000 Key Switches	Application Note	Details on key switch options

## 5.6 Appendix 6 –Network Design Principles

This section gives recommendations on the design of the installation to cover specific EN54-2 requirements and typical national codes of practice.

[EN54-2: 1997, Clause 13.7] Not more than 512 fire detectors and / or manual call points and their associated mandatory functions shall be affected as a result of a system fault in the C.I.E.

### 5.6.1 Mandatory Functions

For full compliance with the requirements in EN54-2, the configuration and operation of all mandatory outputs shall comply with the guidelines below.

Sounder Devices [EN54-2: 1997 Clause 7.8]:

Care should be taken with the cause and effect programming to ensure that any sounder / sounder output is configured such that its fire response operation will only be affected if there is a system fault on the chassis / panel to which it is directly connected.

Consideration should also be given to the applicable code of practice or national standard regulations for fire systems installation (for example BS5839-1: 2002) for installation and operation of sounder devices.

Fire & Fault Routing [EN54-2: 1997 Clauses 7.9 & 8.9]:

Network: If provided, then at least two fire and fault routing interfaces or a fail-safe redundant connection shall be provided. These should be programmed to report all fire and all fault conditions. See 2.5.12 for further information.

### 5.6.2 Network Wiring

Where the installation design and codes of practice deem the network connections to be a 'Critical Signal Path' then consideration should be given to the use of the *Ad-NeT-Plus*<sup>®</sup> Fault Tolerant Network. For further information see document HS680-502.

In addition, the routing and type of cables employed is important to limit the risk of multiple failures causing overall or partial loss of the network functions. BS5839-1: 2002 Sections 24-2 and 26.2 provide a useful guide.

- Use fire resisting cables.
- Configure the network as a loop.
- Employ diverse routing of incoming and outgoing circuits, except in the immediate vicinity of the sub-panel.
- There is no loss of communication to any sub-panel in the event of a single open or short circuit on the loop.

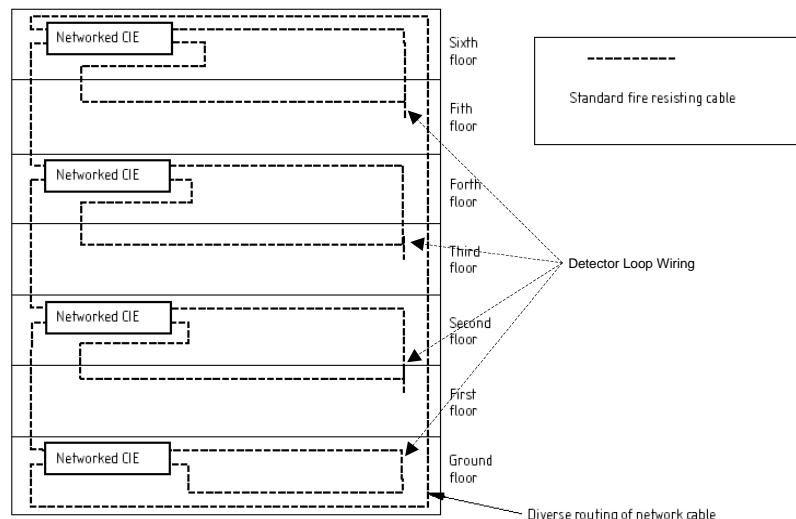

### 5.6.3 Parent Functions

Parent functions shall be provided with a redundant capability. Typical parent functions are Fire Routing, Fault Routing and Fire Brigade Panels.

## 5.7 Appendix 7 – HS Series Product Capabilities / Max Limits

This section gives details on the maximum capabilities for each of the products in the range. Some of the items can only be utilised via the PC CONFIG tool and these are annotated accordingly.

Item	5100	5200	5400	5800	5020	MXP- 510	Comments
Max No of Loops	1	2	4	8	0	0	
Max No of Resident Zones	200	200	200	200 <sup>2</sup>	100	200	
Highest Resident Zone No	2000	2000	2000	2000	2000	2000	
Max No of System Zones	2000	2000	2000	2000	2000	2000	
Max No of Points	2000	2000	2000	2000	9	-	
No of On-board Points	Depends on optional cards fitted						
No of On-board Sounders	2	2	4	8	0	0	
No of On-board Relays (including MXP-507 Card)	2(4)	2(4)	2(4)	4(8)	0	0	
No of Switch Inputs	9	9	9	18	9	-	
Max No of Time Clocks	10	10	10	10	--	3	
Max No of Ringing Styles	40	40	40	40	10	10	
Max No of Output Groups	200	200	200	200	200	200	
Max No of Output Group Lines	2000	2000	2000	2000	250	250	Requires PC CONFIG to define more than one line per Output Group
Max No of Passwords	12	12	12	12	12	12	
Max No of Sectors Available	200	200	200	200	200	200	PC CONFIG Only
Max No of Input Events	2000	2000	2000	2000	250	250	PC CONFIG Only
Max No of Logic Blocks	250	250	250	250	100	100	PC CONFIG Only
Max No of Logic Terms <sup>27</sup>	3000	3000	3000	3000	500	500	PC CONFIG Only
Max First Loop No	99	98	96	96	--	--	PC CONFIG Only

This page is intentionally blank.

Doc Number: UI-ELAN-01

Revision: 07